

# Analysis of Multiaxial Elastic-Plastic Stress and Strain States at Notches Induced by Non-Proportional Loading Paths

June 2<sup>nd</sup> – 6<sup>th</sup>, 2014,  
**Aalto University**,  
Espoo, Finland

Prof. **Grzegorz Glinka**  
University of Waterloo, Canada



# **Multiaxial Elastic-Plastic Notch Tip Stresses and Strains Induced by Non-Proportional Cyclic Loading Histories ???!**



# Smooth laboratory specimens used for the determination of the $\sigma - \epsilon$ material stress-strain curve

$$\sigma_{ij} = \begin{bmatrix} 0 & 0 & 0 \\ 0 & \sigma_{yy} & 0 \\ 0 & 0 & 0 \end{bmatrix}$$

$$\epsilon_{ij} = \begin{bmatrix} \epsilon_{xx} & 0 & 0 \\ 0 & \epsilon_{yy} & 0 \\ 0 & 0 & \epsilon_{zz} \end{bmatrix}$$

$$\nu = -\epsilon_{xx}/\epsilon_{yy} = -\epsilon_{zz}/\epsilon_{yy}$$

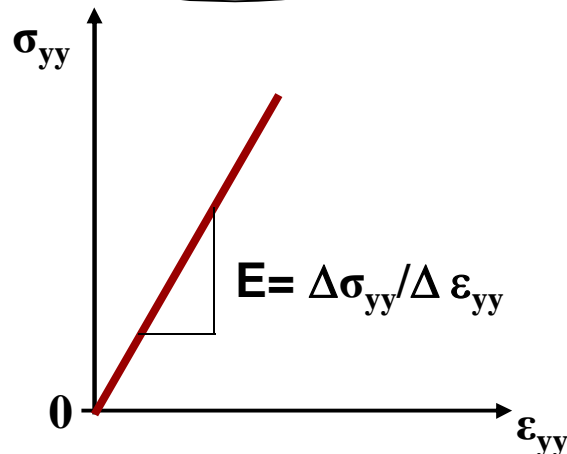
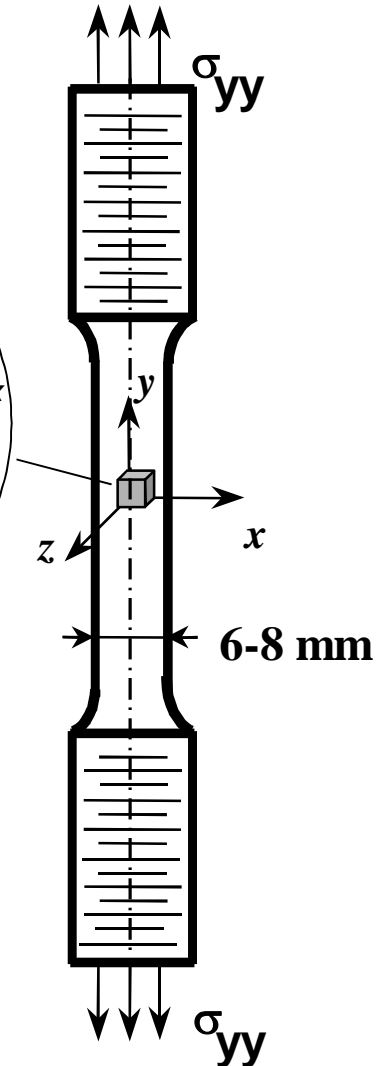
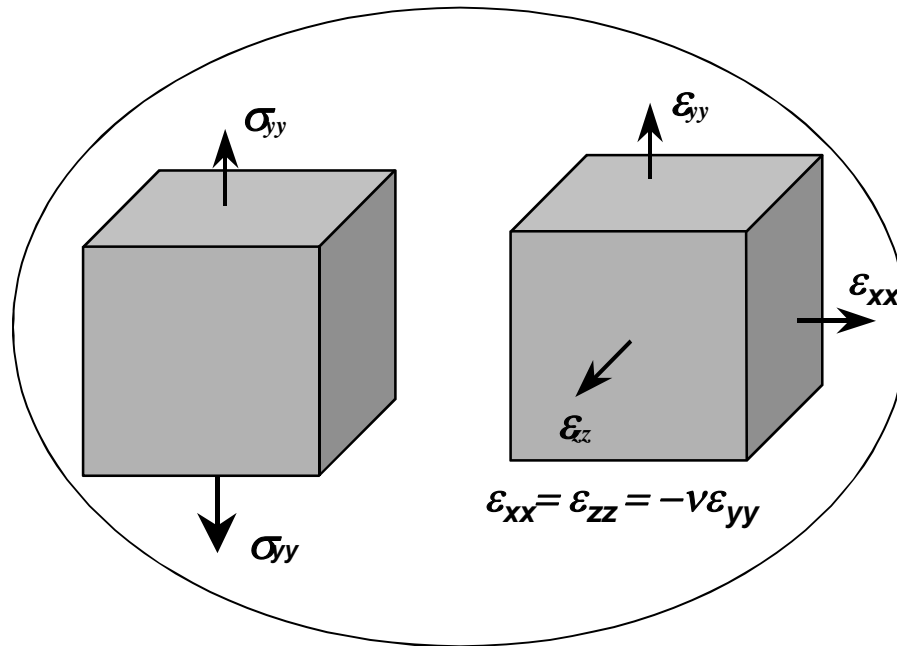

Stress and strain state in a specimen used for the determination of material properties

# The stress state at a point in a body

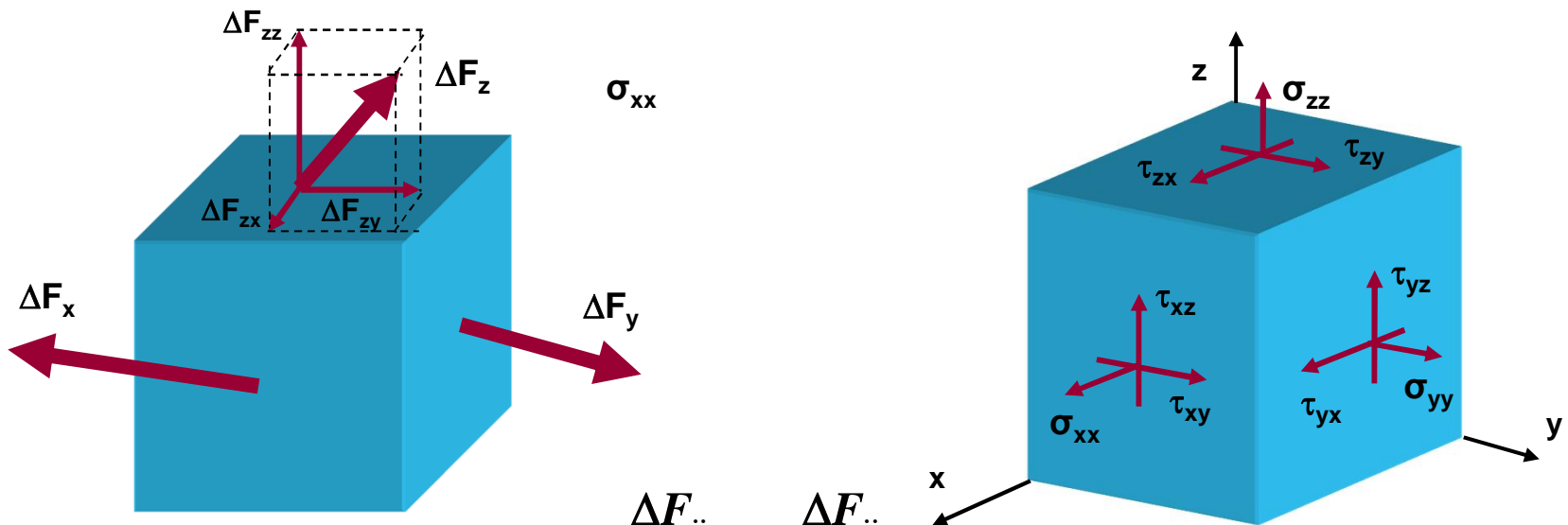
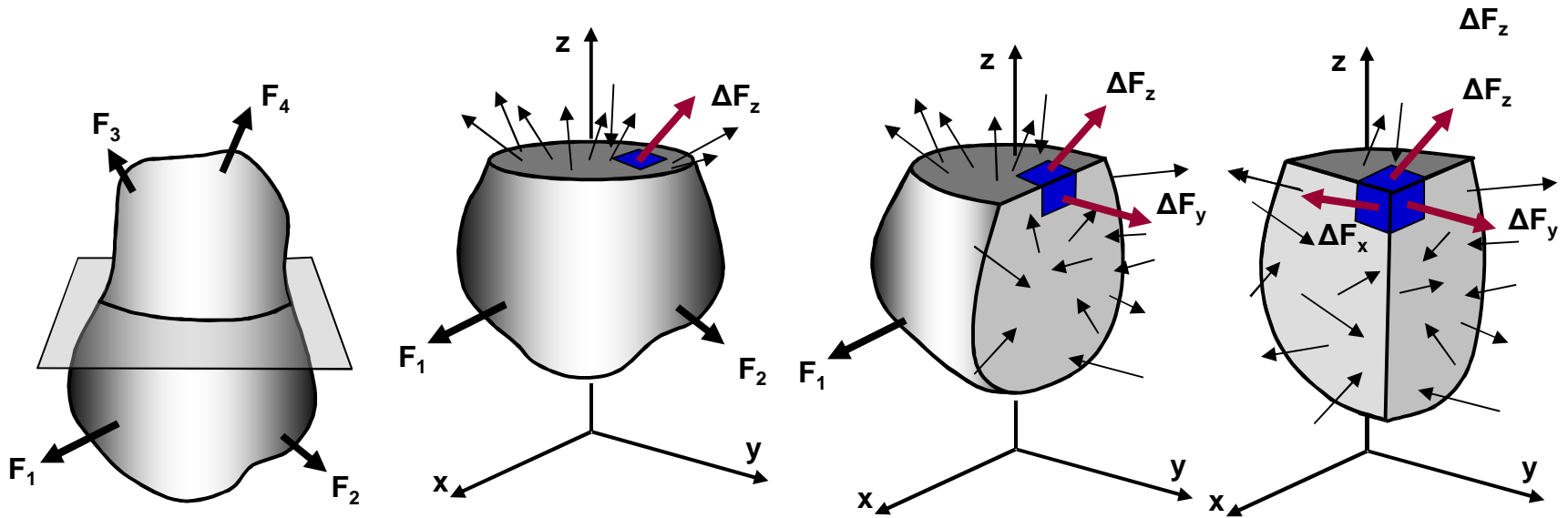

$$\sigma_{ij} = \lim_{\Delta A_{kl} \rightarrow 0} \frac{\Delta F_{ij}}{\Delta A_{kl}} \cong \frac{\Delta F_{ij}}{\Delta x_k \Delta x_l}$$

# Strains in terms of Stresses in the elastic state – The Hooke law

$$\begin{aligned}\varepsilon_{xx} &= \frac{1}{E} \left[ \sigma_{xx} - \nu (\sigma_{yy} + \sigma_{zz}) \right]; & \varepsilon_{xy} &= \frac{\tau_{xy} (1 + \nu)}{E} \\ \varepsilon_{yy} &= \frac{1}{E} \left[ \sigma_{yy} - \nu (\sigma_{zz} + \sigma_{xx}) \right]; & \varepsilon_{yz} &= \frac{\tau_{yz} (1 + \nu)}{E} \\ \varepsilon_{zz} &= \frac{1}{E} \left[ \sigma_{zz} - \nu (\sigma_{xx} + \sigma_{yy}) \right]; & \varepsilon_{zx} &= \frac{\tau_{zx} (1 + \nu)}{E}\end{aligned}$$

**Valid when:**

$$\sigma_{eq} \leq \sigma_0 = \sigma_{0.2} = \sigma_{yield}$$

$$\sigma_{eq} = \frac{1}{\sqrt{2}} \sqrt{(\sigma_{xx} - \sigma_{yy})^2 + (\sigma_{yy} - \sigma_{zz})^2 + (\sigma_{zz} - \sigma_{xx})^2 + 6(\tau_{xy}^2 + \tau_{yz}^2 + \tau_{zx}^2)}$$

# Fluctuations and complexity of the stress state at the notch tip

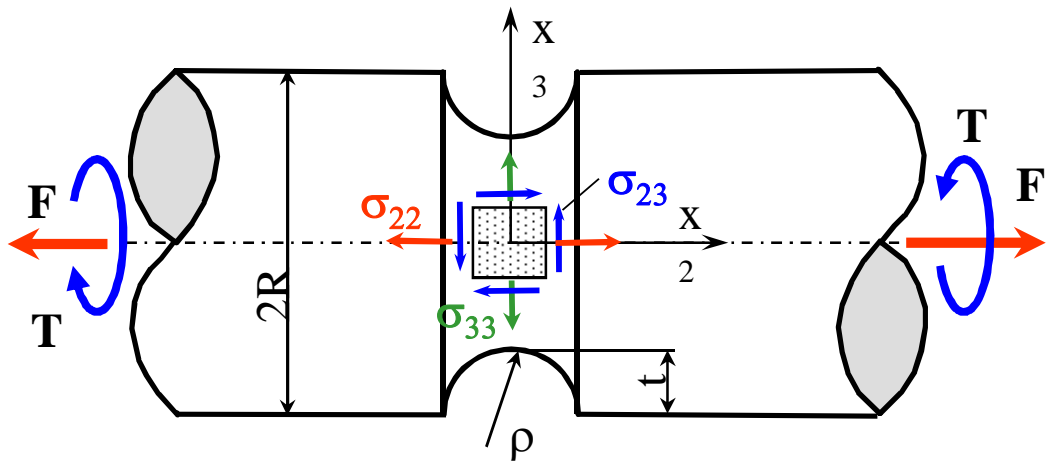

Non-proportional loading path

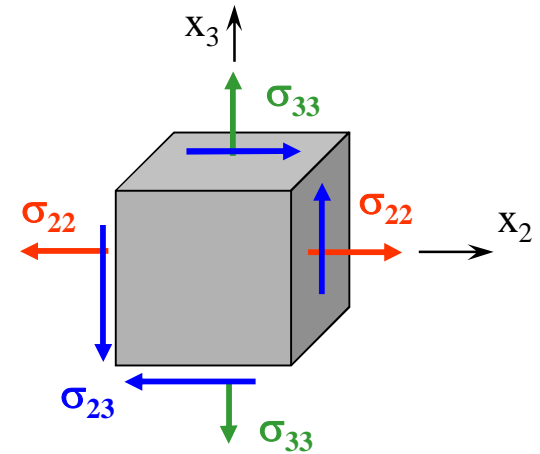

Proportional loading path

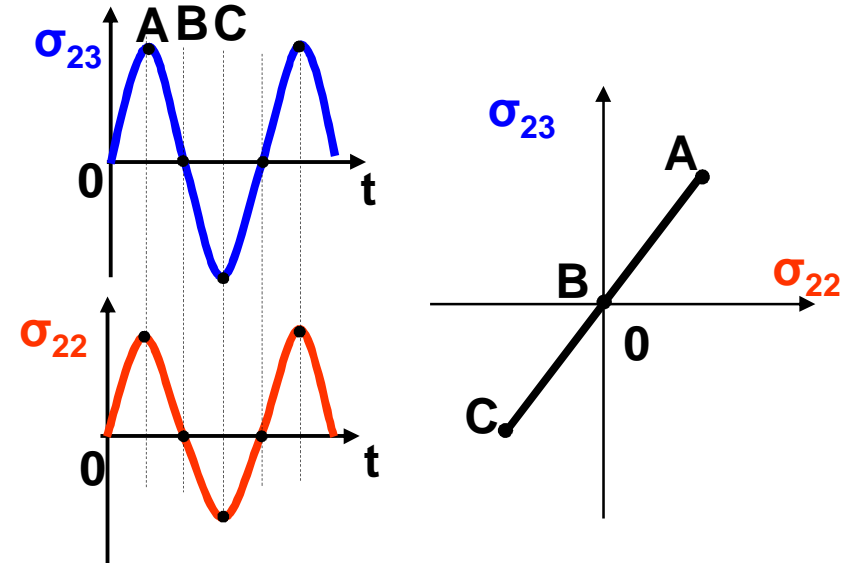
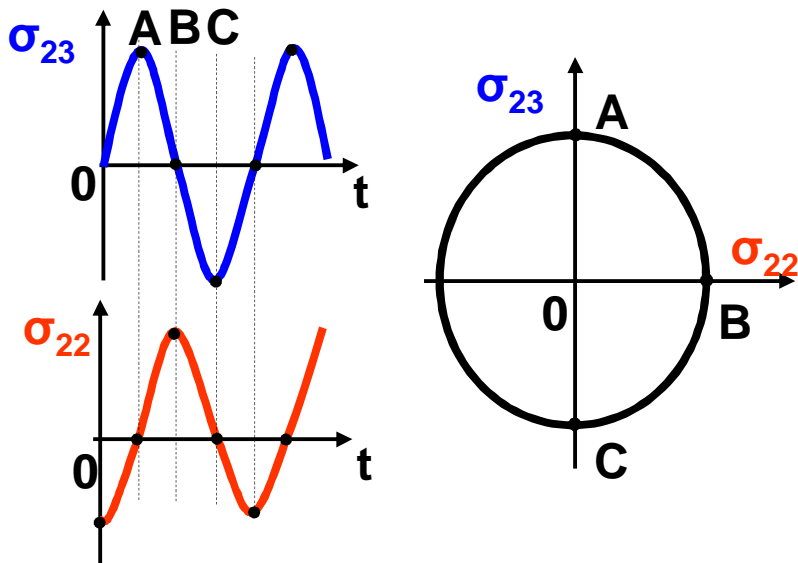

# Various mathematical approximations of uniaxial material stress-strain curves in the elastic-plastic stress state

General form of the  $\sigma$ - $\epsilon$  material curve

$$\epsilon_{yy} = \epsilon_{eyy} + \epsilon_{pyy} = \frac{\sigma_{yy}}{E} + f(\sigma_{yy})$$

Ramberg-Osgood  $\sigma$ - $\epsilon$  material curve

$$\epsilon_{yy} = \epsilon_{eyy} + \epsilon_{pyy} = \frac{\sigma_{yy}}{E} + \left( \frac{\sigma_{yy}}{K} \right)^{\frac{1}{n}}$$

Bi-linear  $\sigma$ - $\epsilon$  material curve

$$\begin{aligned} \epsilon_{yy} &= \epsilon_{eyy} + \epsilon_{pyy} \\ &= \frac{\sigma_{yy}}{E} + (\sigma_{yy} - \sigma_0) \left( \frac{1}{H} - \frac{1}{E} \right) \end{aligned}$$

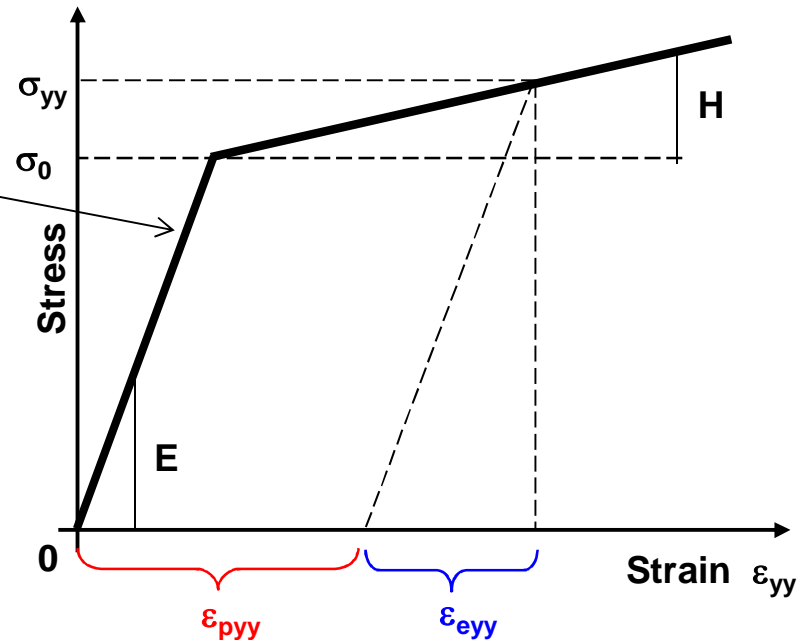
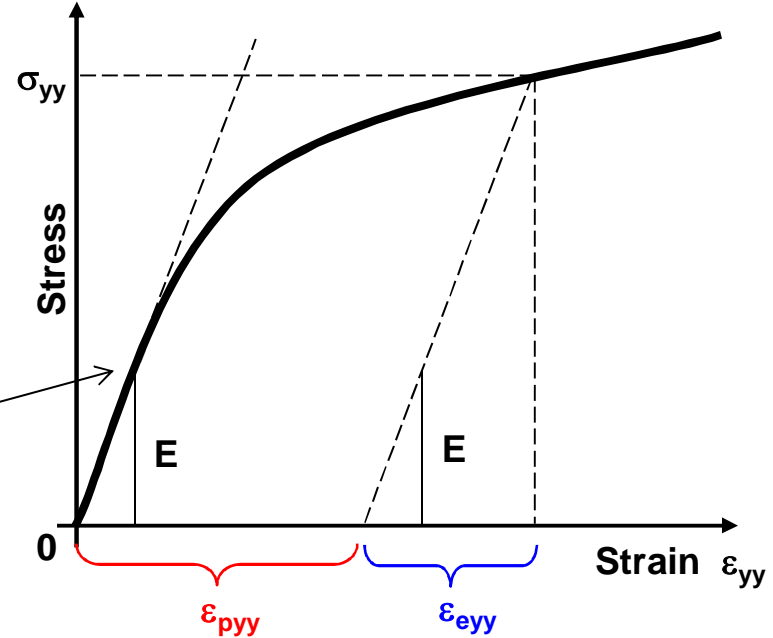

A key feature of the deformation theory of plasticity (**proportional loading**) is its prediction that a single curve relates the equivalent stress,  $\sigma_{eq}$ , and the equivalent plastic strain,  $\varepsilon_{peq}$ , for all stress states.

$$\varepsilon_{p,eq} = f(\sigma_{eq})$$

The function  $f(\sigma_{eq})$  depends on the material and it is the same as the uni-axial stress-strain relationship determined from uni-axial tension tests, i.e.

$$\varepsilon_{p,yy} = f(\sigma_{yy}) \qquad \varepsilon_{p,eq} = f(\sigma_{eq})$$

**The function  $f(\sigma)$  can be determined experimentally from an uni-axial tension test** (see examples);

### Uniaxial Ramberg-Osgood stress-strain curve

$$\varepsilon_{yy} = \varepsilon_{e,yy} + \varepsilon_{p,yy} = \frac{\sigma_{yy}}{E} + \left( \frac{\sigma_{yy}}{K} \right)^{\frac{1}{n}}$$

Plastic strain in the uni-axial stress state

$$\varepsilon_{p,yy} = \left( \frac{\sigma_{yy}}{K} \right)^{1/n} ;$$

Equivalent plastic strain in the multi-axial stress state

$$\varepsilon_{p,eq} = \left( \frac{\sigma_{eq}}{K} \right)^{1/n}$$



# Strains vs. Stresses in Hencky's Total Deformation Theory of Plasticity

$$\varepsilon_{xx} = \frac{1}{E} \left[ \sigma_{xx} - \nu(\sigma_{yy} + \sigma_{zz}) \right] + \frac{1}{E_p} \left[ \sigma_{xx} - \frac{1}{2}(\sigma_{yy} + \sigma_{zz}) \right]$$

$$\varepsilon_{yy} = \frac{1}{E} \left[ \sigma_{yy} - \nu(\sigma_{zz} + \sigma_{xx}) \right] + \frac{1}{E_p} \left[ \sigma_{yy} - \frac{1}{2}(\sigma_{zz} + \sigma_{xx}) \right]$$

$$\varepsilon_{zz} = \frac{1}{E} \left[ \sigma_{zz} - \nu(\sigma_{xx} + \sigma_{yy}) \right] + \frac{1}{E_p} \left[ \sigma_{zz} - \frac{1}{2}(\sigma_{xx} + \sigma_{yy}) \right]$$

$$\gamma_{xy} = \frac{2(1+\nu)}{E} \tau_{xy} + \frac{3}{E_p} \tau_{xy}$$

where:

$$\gamma_{yz} = \frac{2(1+\nu)}{E} \tau_{yz} + \frac{3}{E_p} \tau_{yz}$$

$$\gamma_{zx} = \frac{2(1+\nu)}{E} \tau_{zx} + \frac{3}{E_p} \tau_{zx}$$

$$E_p = \frac{\sigma_{eq}}{\varepsilon_{peq}} = \frac{\sigma_{eq}}{f(\sigma_{peq})}$$

**These are the Hencky equations of the total deformation theory of plasticity!!**

## Proportional Multiaxial Loading

Stress-Strain Equations of Total Deformation Plasticity

$$\boldsymbol{\varepsilon}_{ij} \frac{1+\nu}{E} \sigma_{ij} - \frac{\nu}{E} \sigma_{kk} \delta_{ij} + \frac{3}{2} \frac{\boldsymbol{\varepsilon}_{eq}^p}{\sigma_{eq}} S_{ij}$$

Where:

$$\sigma_{eq} = \sqrt{\frac{3}{2} S_{ij} S_{ij}}$$

$$\boldsymbol{\varepsilon}_{eq}^p = \sqrt{\frac{2}{3} \boldsymbol{\varepsilon}_{ij}^p \boldsymbol{\varepsilon}_{ij}^p}$$

$$S_{ij} = \sigma_{ij} - \frac{1}{3} \sigma_{kk} \delta_{ij}$$

$$\sigma_{kk} = \sigma_{11} + \sigma_{22} + \sigma_{33}$$

Uniaxial

$$\boldsymbol{\varepsilon}_{22} = \frac{\sigma_{22}}{E} + f(\sigma_{22})$$

Multiaxial

$$\boldsymbol{\varepsilon}_{eq}^p = f(\sigma_{eq})$$

# Stresses in a prismatic notched body

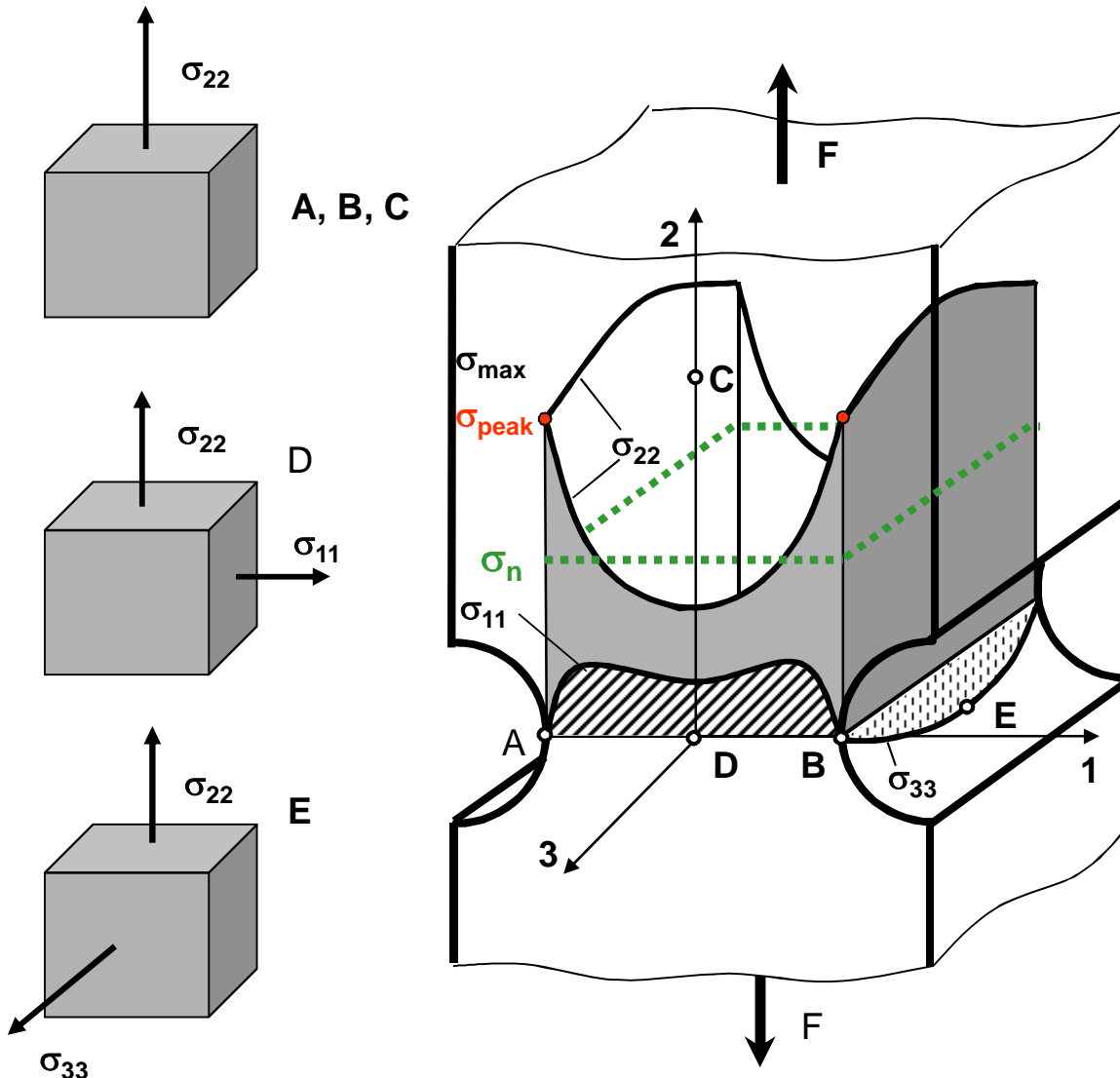

$$\sigma_n = S = \frac{F}{A}$$

and

$$\sigma_{peak} = K_t \sigma_n$$

# Stresses in axisymmetric notched body

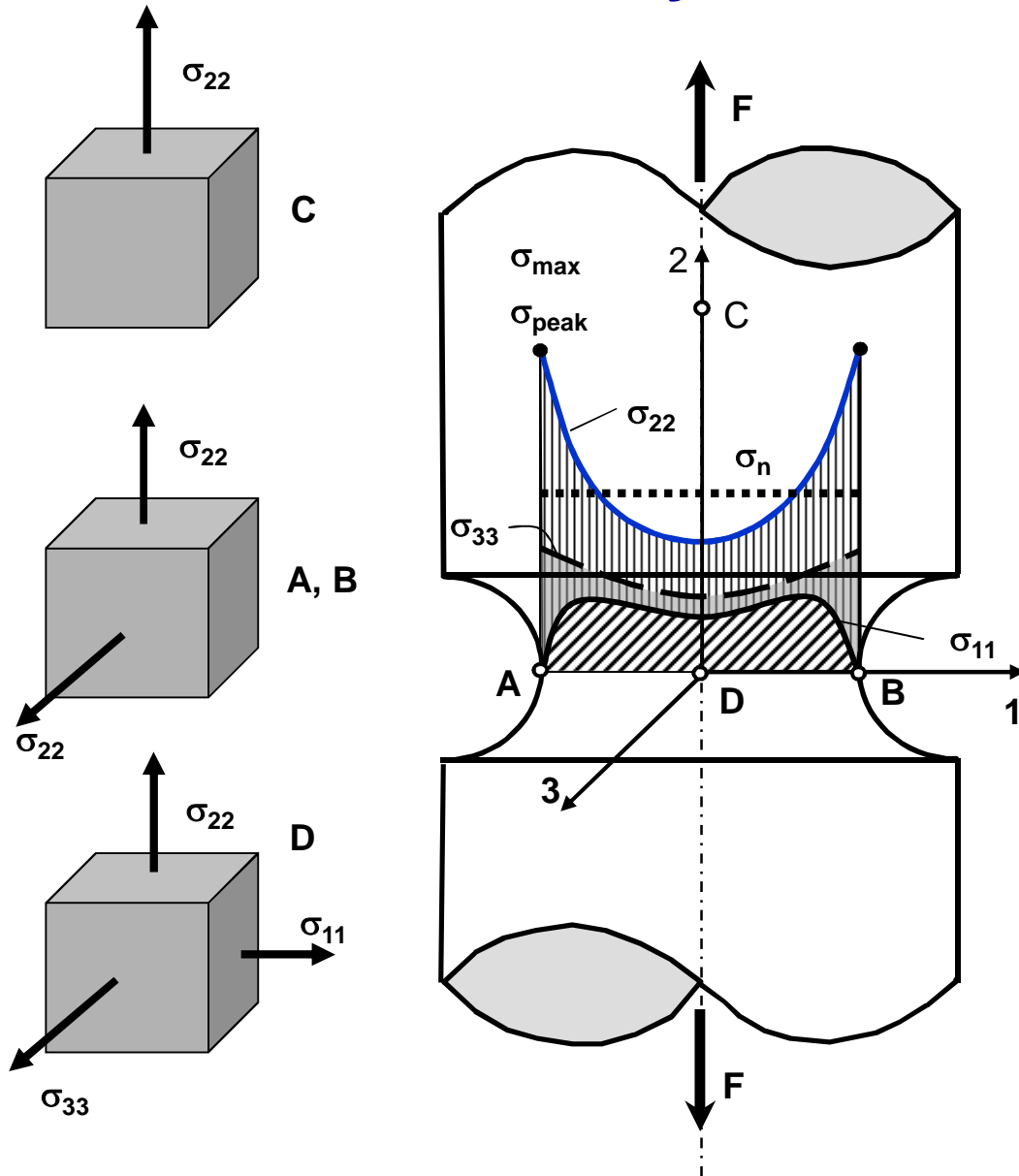

$$\sigma_n = S = \frac{F}{A}$$

and

$$\sigma_{peak} = K_t \sigma_n$$

# Stress State at The Notch Tip

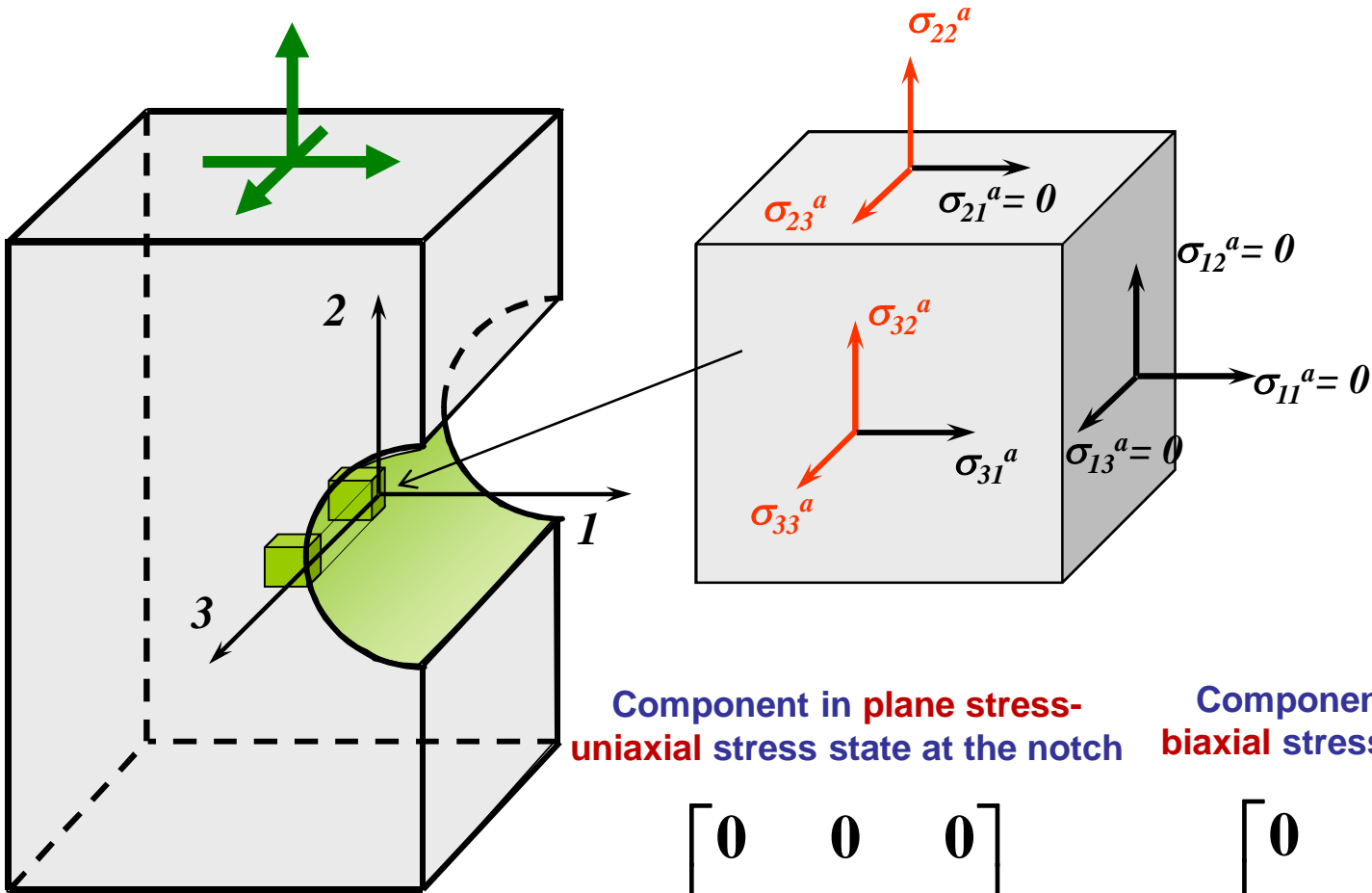

Component in plane stress-  
uniaxial stress state at the notch

Component in plane strain-  
biaxial stress state at the notch

$$\sigma_{ij}^a = \begin{bmatrix} 0 & 0 & 0 \\ 0 & \sigma_{22}^a & 0 \\ 0 & 0 & 0 \end{bmatrix}; \quad \sigma_{ij}^a = \begin{bmatrix} 0 & 0 & 0 \\ 0 & \sigma_{22}^a & 0 \\ 0 & 0 & \sigma_{33}^a \end{bmatrix}$$

# Neuber's Rule

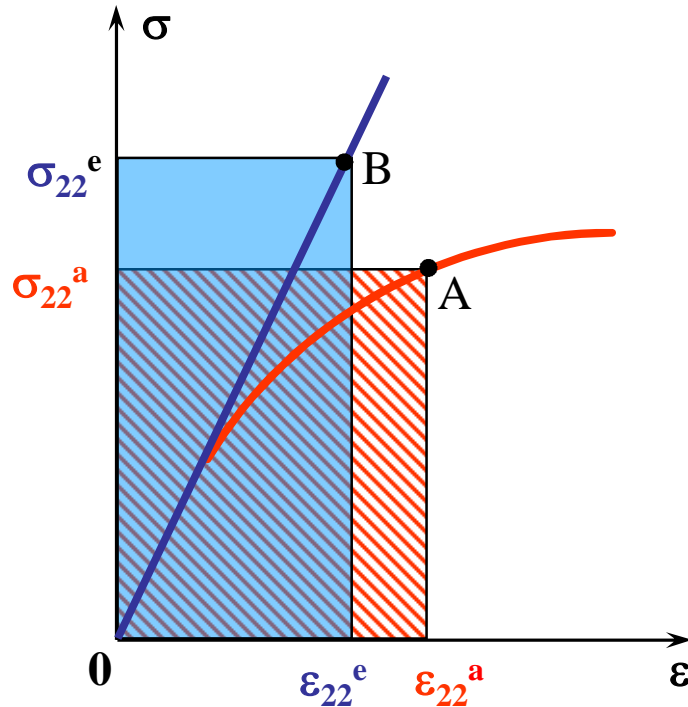

$$\left\{ \begin{aligned} \frac{(\sigma_n K_t)^2}{E} &= \sigma_{22}^e \varepsilon_{22}^e = \sigma_{22}^a \varepsilon_{22}^a \\ \varepsilon_{22}^a &= \frac{\sigma_{22}^a}{E} + f(\sigma_{22}^a) \end{aligned} \right.$$

# The ESED Method

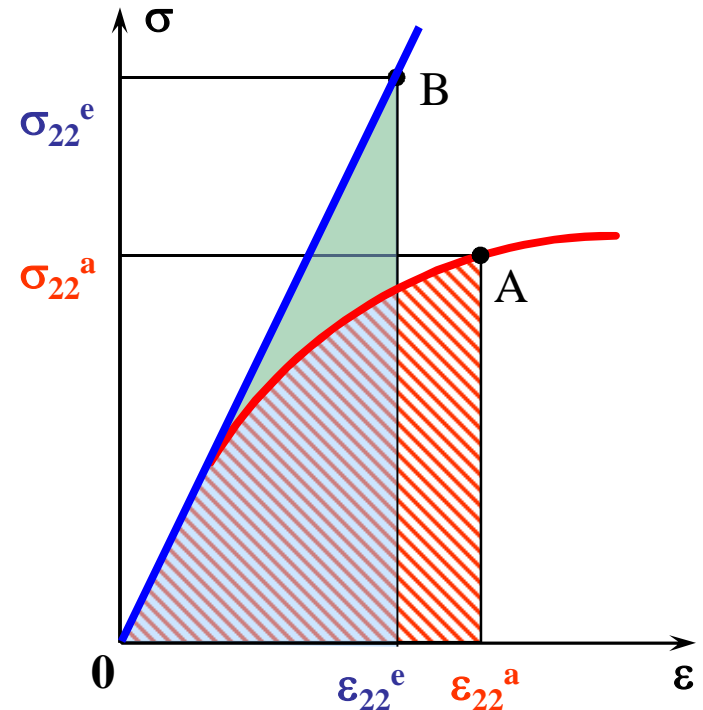

$$\left\{ \begin{aligned} \frac{(\sigma_n K_t)^2}{2E} &= \frac{\sigma_{22}^e \varepsilon_{22}^e}{2} = \int_0^{\varepsilon_{22}^a} \sigma_{22}^a d\varepsilon_{22}^a \\ \varepsilon_{22}^a &= \frac{\sigma_{22}^a}{E} + f(\sigma_{22}^a) \end{aligned} \right.$$

# The Neuber Rule in the Uniaxial stress State

(notch tip in plane stress state)

The strain-stress constitutive equations and the Neuber rule for a notch tip in plane stress ( $\sigma_{11} = \sigma_{33} = 0$ ) state can be written as:

$$\varepsilon_{11}^a = -\frac{\nu \sigma_{22}^a}{E} - \frac{f(\sigma_{22}^a)}{2} \dots \dots \dots (a)$$

$$\varepsilon_{22}^a = \frac{\sigma_{22}^a}{E} + f(\sigma_{eq}^a) \dots \dots \dots (b)$$

$$\varepsilon_{22}^a = -\frac{\nu \sigma_{22}^a}{E} - \frac{f(\sigma_{eq}^a)}{2} \dots \dots \dots (c)$$

$$\varepsilon_{22}^e \sigma_{22}^e = \varepsilon_{22}^a \sigma_{22}^a \dots \dots \dots (d)$$

Where:  $\sigma_{eq}^a = \sigma_{22}^a$

# The Neuber Rule for the notch tip in Plane Strain

The constitutive strain-stress equations and the Neuber rule for a notch tip in plane strain ( $\sigma_{11} = 0$  and  $\epsilon_{33} = 0$ ) state can be written as:

$$\epsilon_{11}^a = -\frac{\nu}{E} \left( \sigma_{22}^a + \sigma_{33}^a \right) - \frac{f(\sigma_{eq}^a)}{2\sigma_{eq}^a} \left( \sigma_{22}^a + \sigma_{33}^a \right) \dots\dots\dots (a)$$

$$\epsilon_{22}^a = \frac{1}{E} \left( \sigma_{22}^a - \nu\sigma_{33}^a \right) + \frac{f(\sigma_{eq}^a)}{2\sigma_{eq}^a} \left( 2\sigma_{22}^a - \sigma_{33}^a \right) \dots\dots\dots (b)$$

$$0 = \frac{1}{E} \left( \sigma_{33}^a - \nu\sigma_{22}^a \right) + \frac{f(\sigma_{eq}^a)}{2\sigma_{eq}^a} \left( 2\sigma_{33}^a - \sigma_{22}^a \right) \dots\dots\dots (c)$$

$$\epsilon_{22}^e \sigma_{22}^e = \epsilon_{22}^a \sigma_{22}^a \dots\dots\dots (d)$$

where:  $\sigma_{eq}^a = \sqrt{\left(\sigma_{22}^a\right)^2 - \sigma_{22}^a \sigma_{22}^a + \left(\sigma_{33}^a\right)^2}$



# Stress state away from the notch tip (in the symmetry plane)

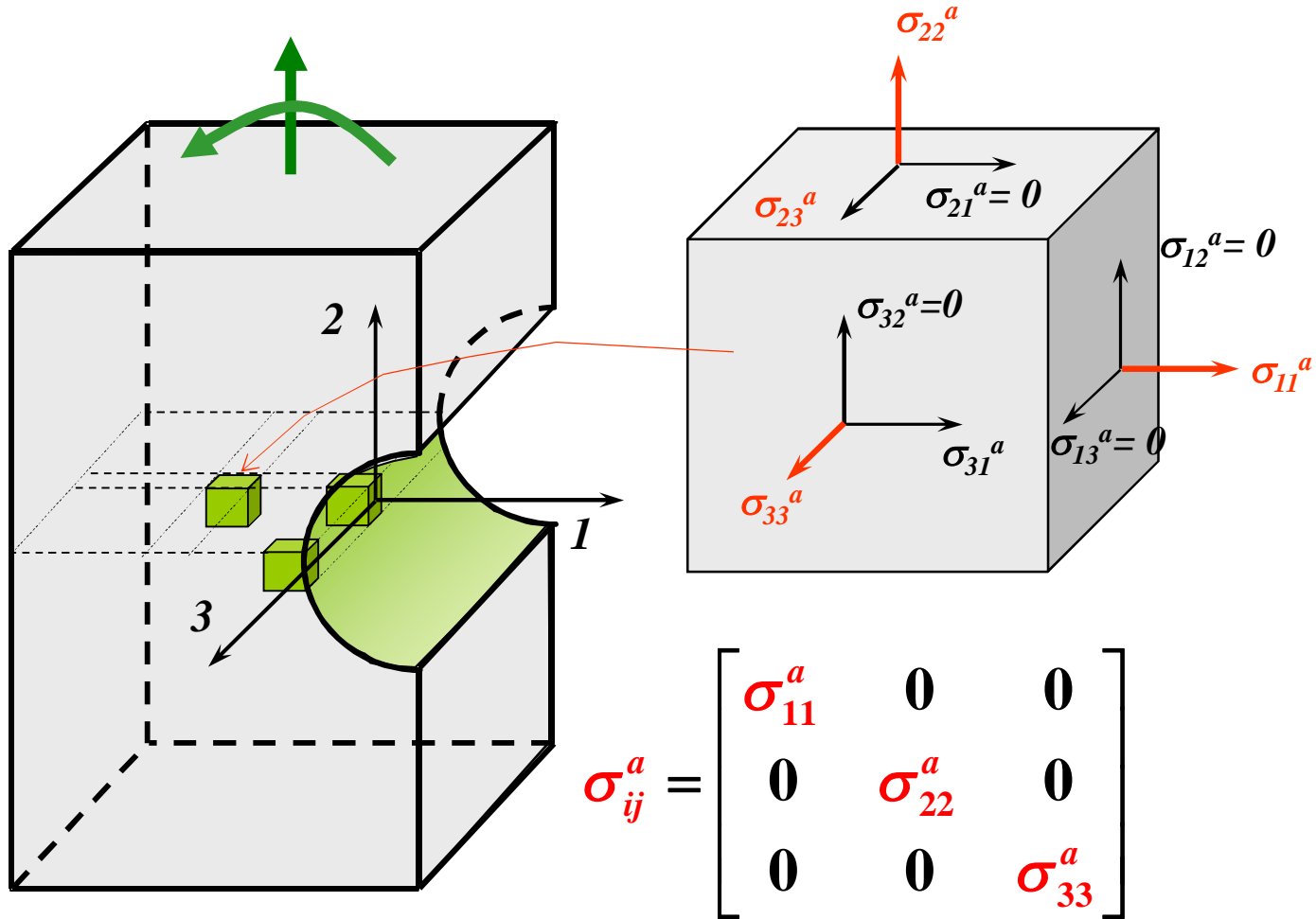

## Equations of the multiaxial Neuber rule and Hencky's plasticity equations (*General tri-axial stress state*)

$$\left\{ \begin{aligned} \varepsilon_{11}^a(\mathbf{x}) &= \frac{1}{E} \left\{ \sigma_{11}^a(\mathbf{x}) - \nu \left[ \sigma_{22}^a(\mathbf{x}) + \sigma_{33}^a(\mathbf{x}) \right] \right\} + \frac{f \left[ \sigma_{eq}^a(\mathbf{x}) \right]}{\sigma_{eq}^a(\mathbf{x})} \left\{ \sigma_{11}^a(\mathbf{x}) - \frac{1}{2} \left[ \sigma_{22}^a(\mathbf{x}) + \sigma_{33}^a(\mathbf{x}) \right] \right\} \\ \varepsilon_{22}^a(\mathbf{x}) &= \frac{1}{E} \left\{ \sigma_{22}^a(\mathbf{x}) - \nu \left[ \sigma_{33}^a(\mathbf{x}) + \sigma_{11}^a(\mathbf{x}) \right] \right\} + \frac{f \left[ \sigma_{eq}^a(\mathbf{x}) \right]}{\sigma_{eq}^a(\mathbf{x})} \left\{ \sigma_{22}^a(\mathbf{x}) - \frac{1}{2} \left[ \sigma_{33}^a(\mathbf{x}) + \sigma_{11}^a(\mathbf{x}) \right] \right\} \\ \varepsilon_{33}^a(\mathbf{x}) &= \frac{1}{E} \left\{ \sigma_{33}^a(\mathbf{x}) - \nu \left[ \sigma_{11}^a(\mathbf{x}) + \sigma_{22}^a(\mathbf{x}) \right] \right\} + \frac{f \left[ \sigma_{eq}^a(\mathbf{x}) \right]}{\sigma_{eq}^a(\mathbf{x})} \left\{ \sigma_{33}^a(\mathbf{x}) - \frac{1}{2} \left[ \sigma_{11}^a(\mathbf{x}) + \sigma_{22}^a(\mathbf{x}) \right] \right\} \\ \sigma_{11}^e(\mathbf{x}) \cdot \varepsilon_{11}^e(\mathbf{x}) &= \sigma_{11}^a(\mathbf{x}) \cdot \varepsilon_{11}^a(\mathbf{x}) \\ \sigma_{22}^e(\mathbf{x}) \cdot \varepsilon_{22}^e(\mathbf{x}) &= \sigma_{22}^a(\mathbf{x}) \cdot \varepsilon_{22}^a(\mathbf{x}) \\ \sigma_{33}^e(\mathbf{x}) \cdot \varepsilon_{33}^e(\mathbf{x}) &= \sigma_{33}^a(\mathbf{x}) \cdot \varepsilon_{33}^a(\mathbf{x}) \end{aligned} \right.$$

$$\text{where : } f \left[ \sigma_{eq}^a(\mathbf{x}) \right] = \left[ \frac{\sigma_{eq}^a(\mathbf{x})}{K'} \right]^{\frac{1}{n'}}$$

$$\text{and } \sigma_{eq}^a(\mathbf{x}) = \frac{1}{\sqrt{2}} \sqrt{\left[ \sigma_{11}^a(\mathbf{x}) - \sigma_{22}^a(\mathbf{x}) \right]^2 + \left[ \sigma_{22}^a(\mathbf{x}) - \sigma_{33}^a(\mathbf{x}) \right]^2 + \left[ \sigma_{33}^a(\mathbf{x}) - \sigma_{11}^a(\mathbf{x}) \right]^2}$$

## Equations of the multiaxial Neuber's rule and Hencky's equations of plasticity (*Plane strain, $\varepsilon_{33}=0$* )

$$\left\{ \begin{array}{l} \varepsilon_{11}^a(x) = \frac{1}{E} \left\{ \sigma_{11}^a(x) - \nu \left[ \sigma_{22}^a(x) + \sigma_{33}^a(x) \right] \right\} + \frac{f \left[ \sigma_{eq}^a(x) \right]}{\sigma_{eq}^a(x)} \left\{ \sigma_{11}^a(x) - \frac{1}{2} \left[ \sigma_{22}^a(x) + \sigma_{33}^a(x) \right] \right\} \\ \varepsilon_{22}^a(x) = \frac{1}{E} \left\{ \sigma_{22}^a(x) - \nu \left[ \sigma_{33}^a(x) + \sigma_{11}^a(x) \right] \right\} + \frac{f \left[ \sigma_{eq}^a(x) \right]}{\sigma_{eq}^a(x)} \left\{ \sigma_{22}^a(x) - \frac{1}{2} \left[ \sigma_{33}^a(x) + \sigma_{11}^a(x) \right] \right\} \\ \mathbf{0} = \frac{1}{E} \left\{ \sigma_{33}^a(x) - \nu \left[ \sigma_{11}^a(x) + \sigma_{22}^a(x) \right] \right\} + \frac{f \left[ \sigma_{eq}^a(x) \right]}{\sigma_{eq}^a(x)} \left\{ \sigma_{33}^a(x) - \frac{1}{2} \left[ \sigma_{11}^a(x) + \sigma_{22}^a(x) \right] \right\} \\ \sigma_{11}^e(x) \cdot \varepsilon_{11}^e(x) = \sigma_{11}^a(x) \cdot \varepsilon_{11}^a(x) \\ \sigma_{22}^e(x) \cdot \varepsilon_{22}^e(x) = \sigma_{22}^a(x) \cdot \varepsilon_{22}^a(x) \end{array} \right.$$

$$\text{where : } f \left[ \sigma_{eq}^a(x) \right] = \left[ \frac{\sigma_{eq}^a(x)}{K'} \right]^{\frac{1}{n'}}$$

$$\text{and } \sigma_{eq}^a(x) = \frac{1}{\sqrt{2}} \sqrt{\left[ \sigma_{11}^a(x) - \sigma_{22}^a(x) \right]^2 + \left[ \sigma_{22}^a(x) - \sigma_{33}^a(x) \right]^2 + \left[ \sigma_{33}^a(x) - \sigma_{11}^a(x) \right]^2}$$

# Cylindrical Notched Specimen under Proportional Tension and Torsion Load

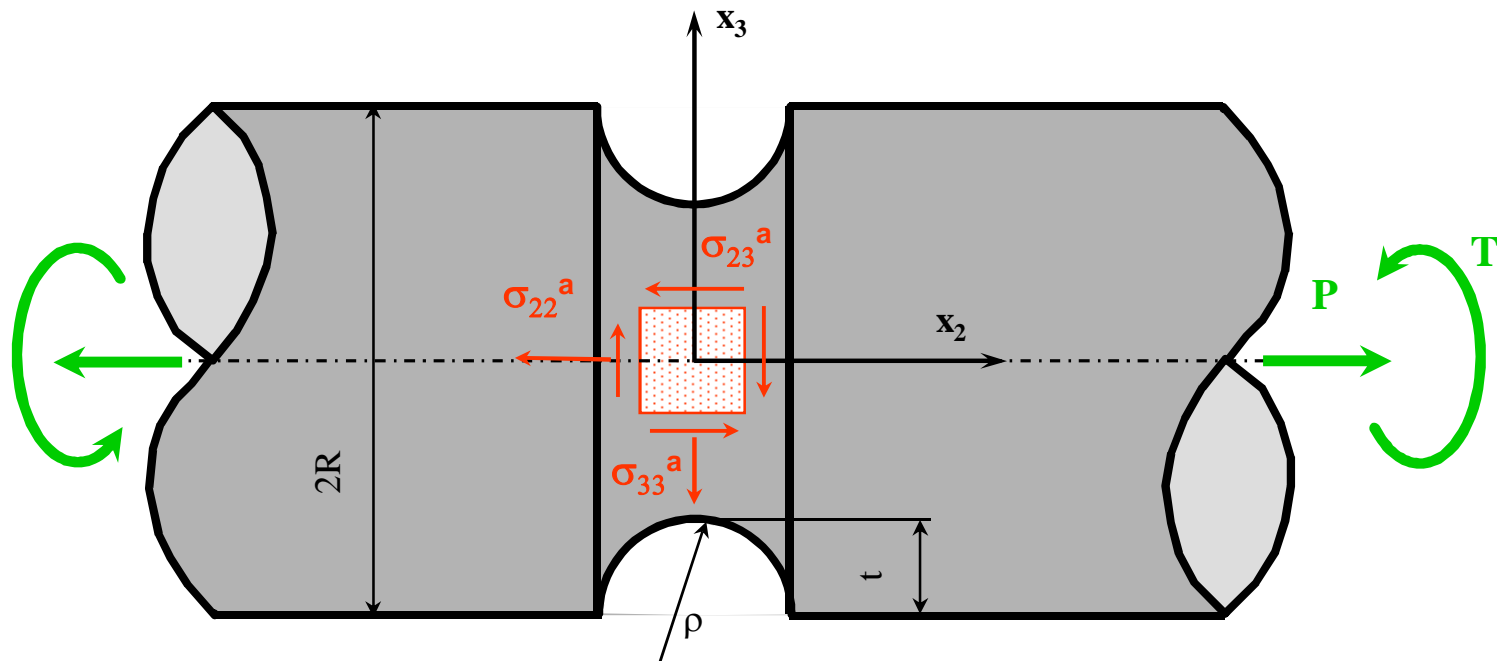

$$\begin{cases} \varepsilon = \frac{\sigma}{E} & \text{for } \sigma \leq \sigma_0 \\ \varepsilon = \frac{\sigma}{E} + \frac{\sigma - \sigma_0}{H} & \text{for } \sigma > \sigma_0 \end{cases}$$

$$K_P = 3.89 \quad K_T = 2.19$$

$$\frac{\sigma_{33}^e}{\sigma_{22}^e} = 0.27 \quad \frac{\tau_n}{\sigma_n} = 0.27$$

$$E = 94400 \text{ MPa}, \nu = 0.3,$$

$$H = 4720 \text{ MPa}, \sigma_0 = 550 \text{ MPa}$$

# Input: Pseudo-Elastic Stress and Strain components at the notch tip (*proportional loading*)

$\sigma_n$  - nominal stress induced by the axial load,  $\sigma_n = P/A$

$\tau_n = 0.27\sigma_n$  - nominal shear stress induced by the torque

The notch tip hypothetical (elastic) stress components

$$\sigma_{11}^e = 0; \quad \sigma_{22}^e = \sigma_n \cdot K_P; \quad \sigma_{33}^e = 0.27\sigma_n \cdot K_P$$

$$\tau_{12}^e = 0; \quad \tau_{23}^e = 0.27 \cdot \sigma_n \cdot K_T; \quad \tau_{31}^e = 0.27\sigma_n \cdot K_T$$

## Pseudo-Elastic Principal Stresses at the notch tip

$$\sigma_2^e = \frac{\sigma_{22}^e + \sigma_{33}^e}{2} + \sqrt{\left(\frac{\sigma_{22}^e - \sigma_{33}^e}{2}\right)^2 + (\tau_{23}^e)^2}$$
$$\sigma_3^e = \frac{\sigma_{22}^e + \sigma_{33}^e}{2} - \sqrt{\left(\frac{\sigma_{22}^e - \sigma_{33}^e}{2}\right)^2 + (\tau_{23}^e)^2}$$
$$\sigma_k^e = \begin{bmatrix} 0 & 0 & 0 \\ 0 & \sigma_2^e & 0 \\ 0 & 0 & \sigma_3^e \end{bmatrix}$$

**Input: Pseudo-Elastic Stress and Strain components  
(Principal Stresses)**

$$\sigma_{ij}^e = \begin{bmatrix} \mathbf{0} & \mathbf{0} & \mathbf{0} \\ \mathbf{0} & \sigma_{22}^e & \mathbf{0} \\ \mathbf{0} & \mathbf{0} & \sigma_{33}^e \end{bmatrix} \quad \text{Hooke's law} \quad \epsilon_{ij}^e = \begin{bmatrix} \epsilon_{11}^e & \mathbf{0} & \mathbf{0} \\ \mathbf{0} & \epsilon_{22}^e & \mathbf{0} \\ \mathbf{0} & \mathbf{0} & \epsilon_{33}^e \end{bmatrix}$$

**Output: Actual Elastic-Plastic Stresses and Strains  
(Principal Stresses)**

$$\sigma_{ij}^N = \begin{bmatrix} \mathbf{0} & \mathbf{0} & \mathbf{0} \\ \mathbf{0} & \sigma_{22}^N & \mathbf{0} \\ \mathbf{0} & \mathbf{0} & \sigma_{33}^N \end{bmatrix} \quad \text{Hencky's Eqns} \quad \epsilon_{ij}^N = \begin{bmatrix} \epsilon_{11}^N & \mathbf{0} & \mathbf{0} \\ \mathbf{0} & \epsilon_{22}^N & \mathbf{0} \\ \mathbf{0} & \mathbf{0} & \epsilon_{33}^N \end{bmatrix}$$

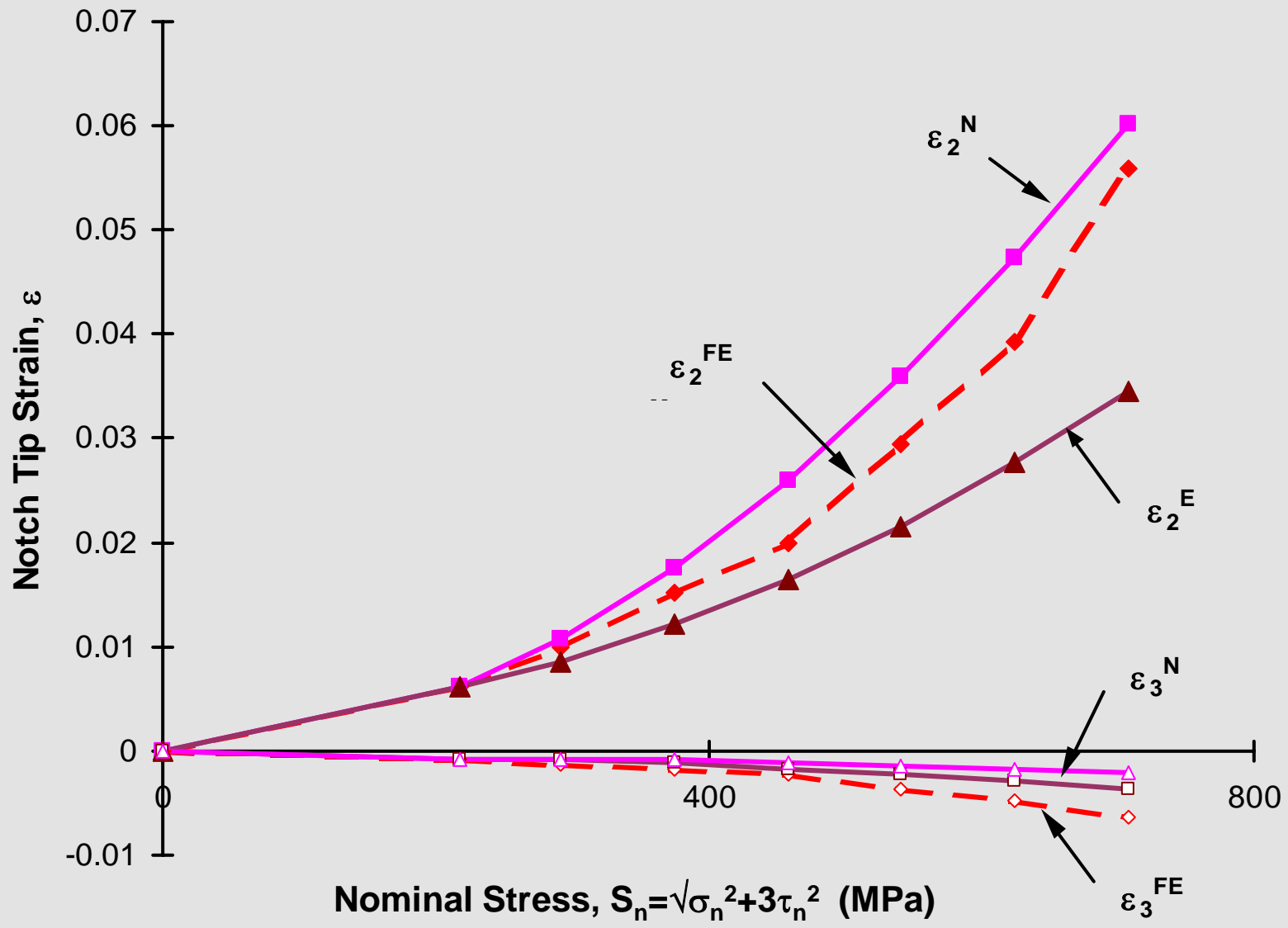

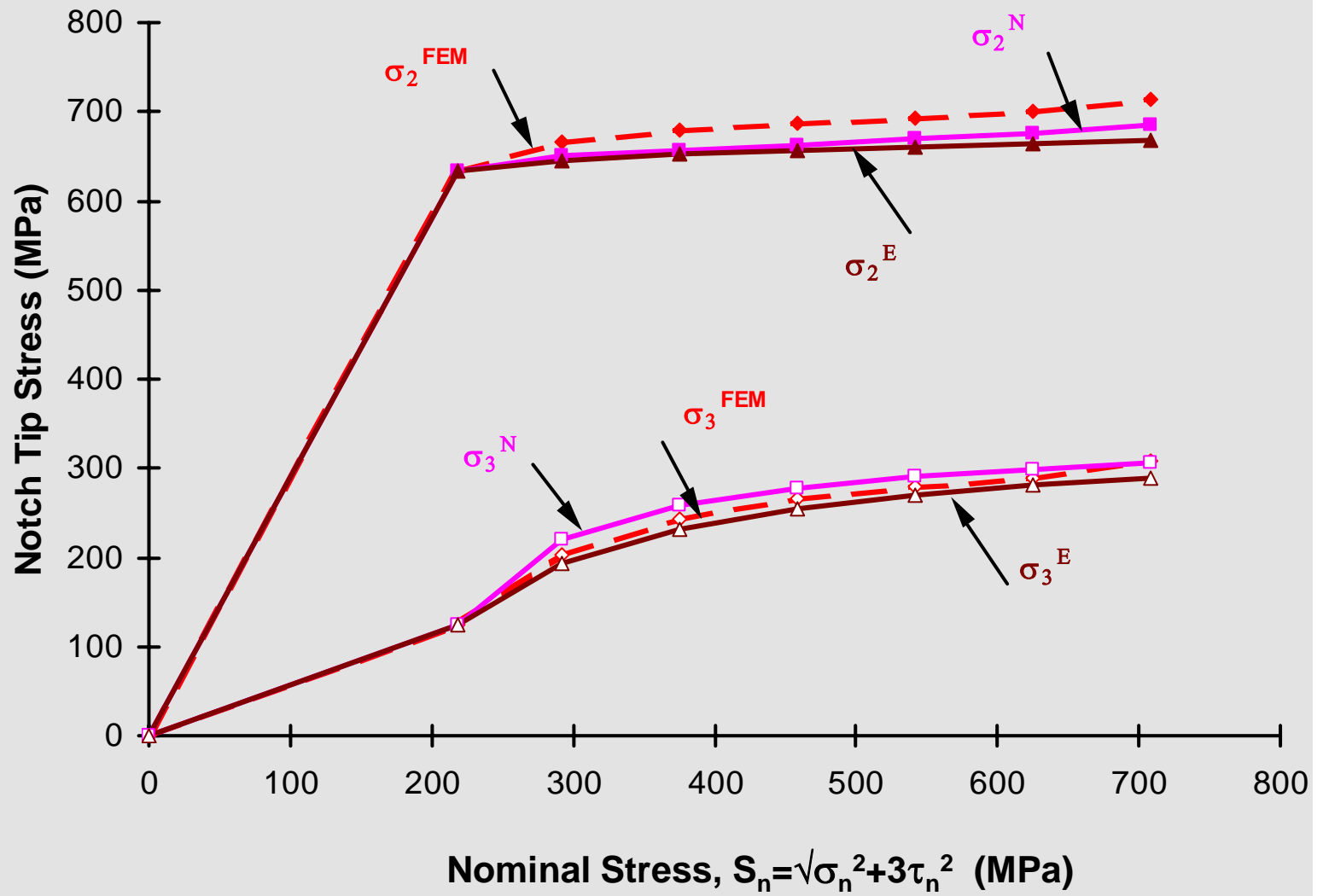



# Plastic deformation induced by non-proportional loading paths

When the stress component ratios change during the loading process (i.e. if the load path is non-proportional the resulting elastic-plastic strains at the load path end are not the same - in spite of the fact that the final loads or corresponding notch tip hypothetical “elastic” stress states are the same.

**The three various load paths below will produce at the end three different stress and strain states. In order to determine the final stress-strain state at the notch tip the load path needs to be followed up incrementally as applied!**

**Therefore the constitutive stress-strain relationships must be written in terms of increments because the current stress-strain increments depend on the previous stress/load path.!**

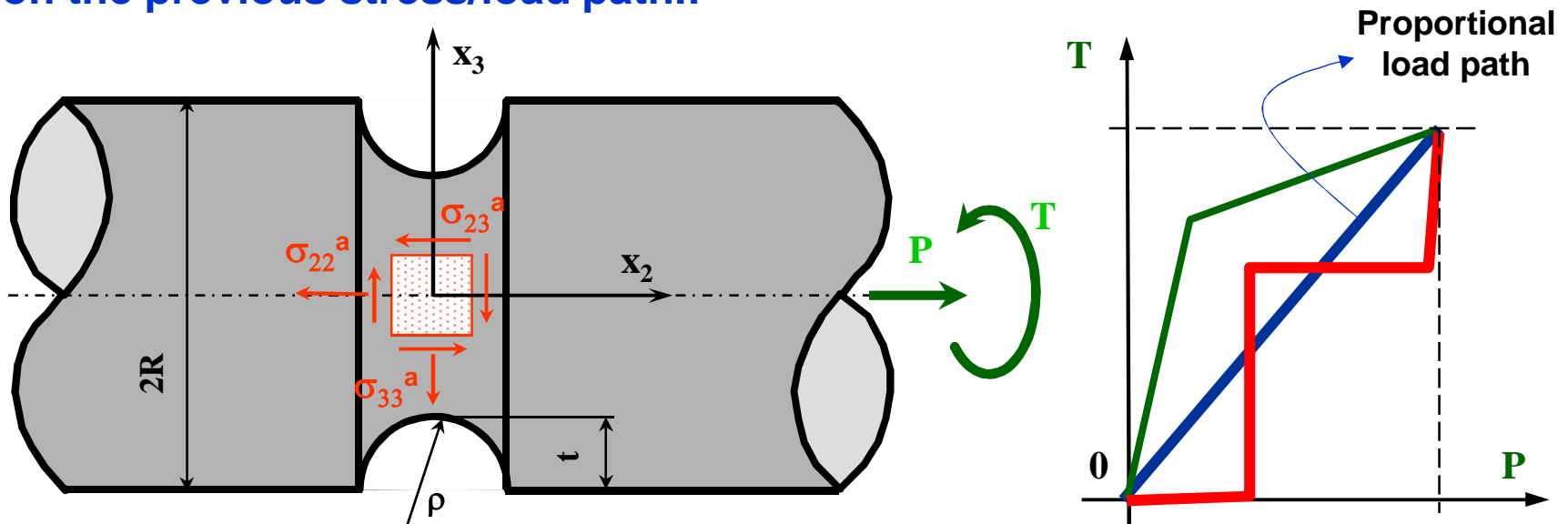

# Incremental Constitutive Stress-Strain Equations of the Incremental Theory of Plasticity

$$\Delta \varepsilon_{11}^a = \frac{1}{E} \left[ \Delta \sigma_{11}^a - \nu \left( \Delta \sigma_{22}^a + \Delta \sigma_{33}^a \right) \right] + \frac{\Delta \sigma_{eq}^a}{H \sigma_{eq}^a} \left[ \sigma_{11}^a - \frac{1}{2} \left( \sigma_{22}^a + \sigma_{33}^a \right) \right]$$

$$\Delta \varepsilon_{22}^a = \frac{1}{E} \left[ \Delta \sigma_{22}^a - \nu \left( \Delta \sigma_{33}^a + \Delta \sigma_{11}^a \right) \right] + \frac{\Delta \sigma_{eq}^a}{H \sigma_{eq}^a} \left[ \sigma_{22}^a - \frac{1}{2} \left( \sigma_{33}^a + \sigma_{11}^a \right) \right]$$

$$\Delta \varepsilon_{33}^a = \frac{1}{E} \left[ \Delta \sigma_{33}^a - \nu \left( \Delta \sigma_{11}^a + \Delta \sigma_{22}^a \right) \right] + \frac{\Delta \sigma_{eq}^a}{H \sigma_{eq}^a} \left[ \sigma_{33}^a - \frac{1}{2} \left( \sigma_{11}^a + \sigma_{22}^a \right) \right]$$

$$\Delta \varepsilon_{12}^a = \frac{(1+\nu)}{E} \Delta \sigma_{12}^a + \frac{3}{2} \frac{\Delta \sigma_{eq}^a}{H \sigma_{eq}^a} \sigma_{12}^a$$

$$\Delta \varepsilon_{23}^a = \frac{(1+\nu)}{E} \Delta \sigma_{23}^a + \frac{3}{2} \frac{\Delta \sigma_{eq}^a}{H \sigma_{eq}^a} \sigma_{23}^a$$

$$\Delta \varepsilon_{13}^a = \frac{(1+\nu)}{E} \Delta \sigma_{13}^a + \frac{3}{2} \frac{\Delta \sigma_{eq}^a}{H \sigma_{eq}^a} \sigma_{13}^a$$

# The Generalized Constitutive 'Stress-Plastic Strain' Material Curve

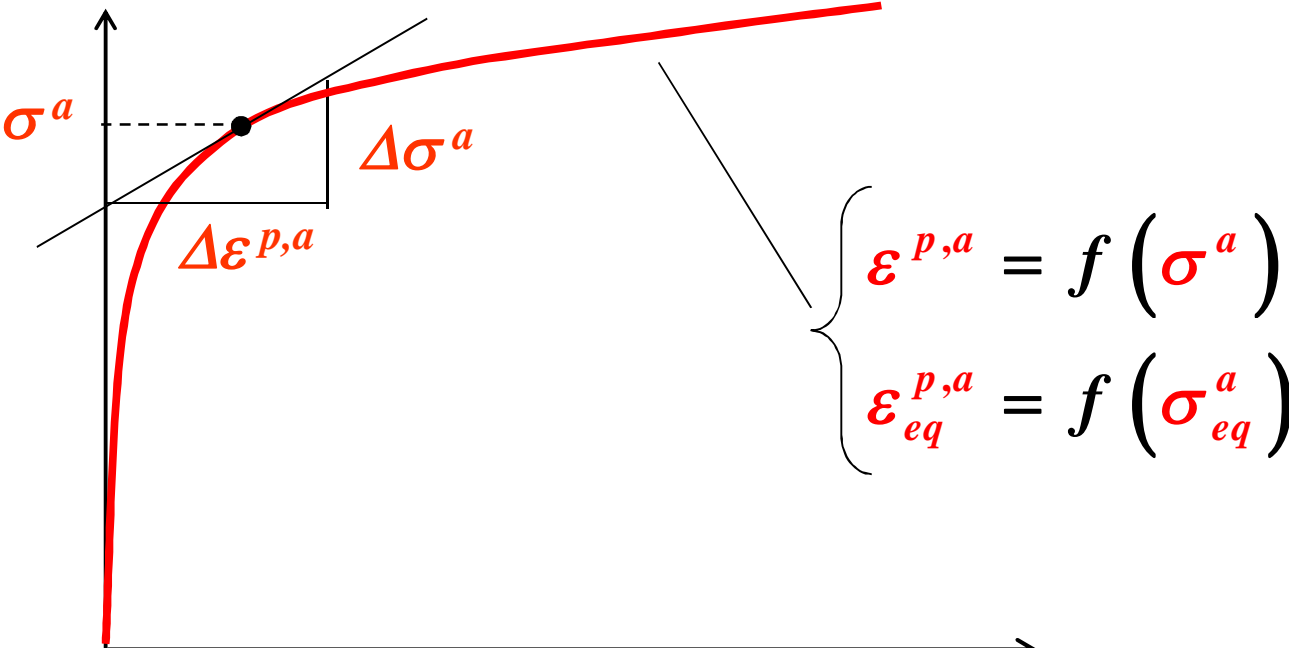

$$\frac{d \epsilon^{p,a}}{d \sigma^a} = \frac{d [f(\sigma^a)]}{d \sigma^a} = \frac{1}{H} \cong \frac{\Delta \epsilon^{p,a}}{\Delta \sigma^a}$$

$$\Delta \epsilon^{p,a} \cong \frac{\Delta \sigma^a}{H} \quad \text{or} \quad H = \frac{1}{\frac{d [f(\sigma^a)]}{d \sigma^a}}$$

# Multiple Plasticity Surfaces of the Mroz-Garud Model

In order to make the numerical analysis easier and more general the constitutive stress-strain curve is approximated by a series of linear segments. It enables to model any stress-strain curve and not only those approximated by the Ramberg-Osgood expression! Each segment is defined by its own modulus 'H'!

As soon as the linear piece with the current stress state is identified (based on the current value of  $\sigma_{eq}$ ) the elastic-plastic strain increments can be determined from the incremental constitutive equations.

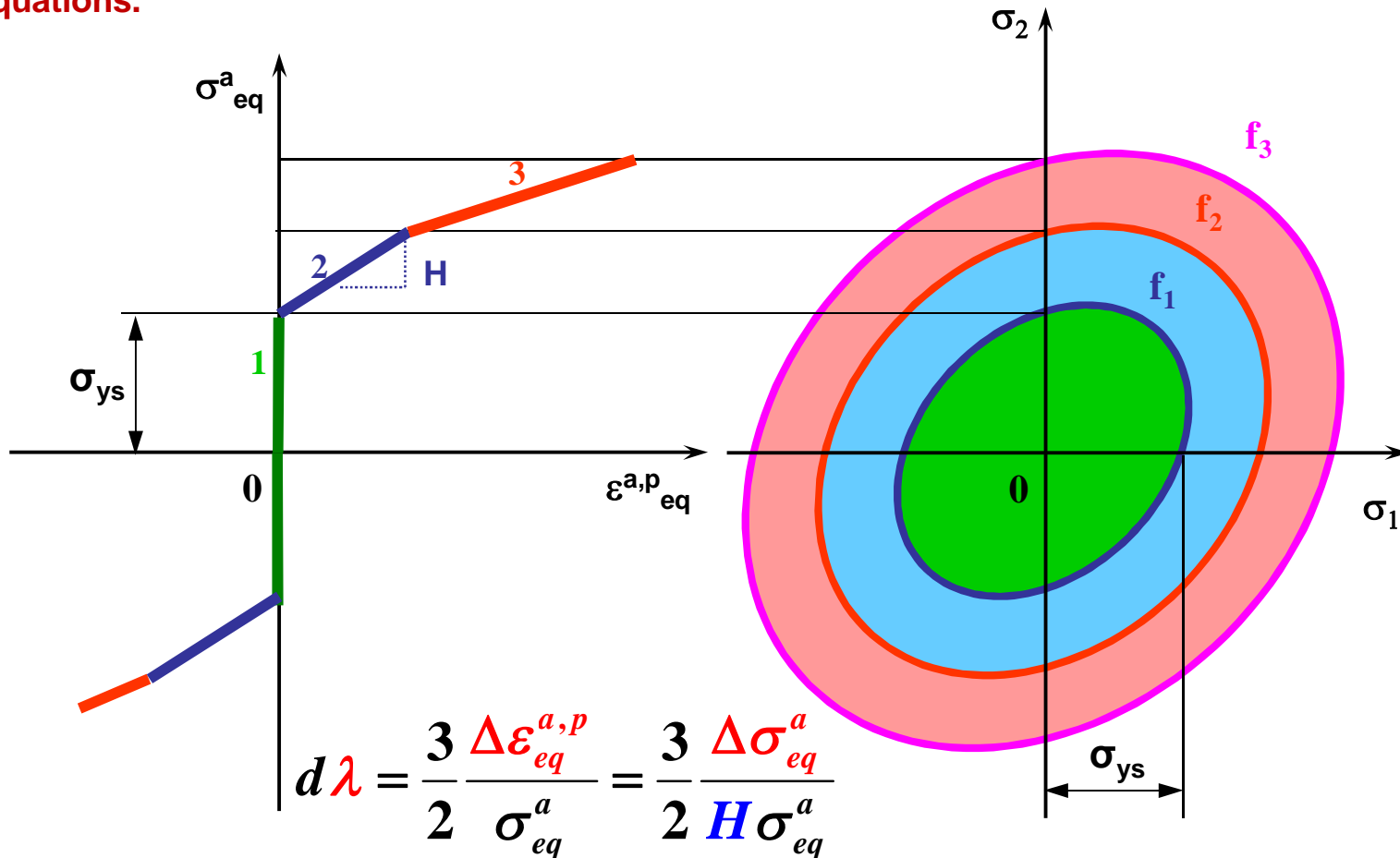

In order to account for the memory effect the plasticity surface associated with the current state (and also current linear segment) is translated in the stress space according to certain rules. The Mroz-Garud model requires such a translation of the current plasticity surface, enforced by the application of stress increments  $\Delta\sigma_{ij}$ , that Points  $B_1$  and  $B_2$ , having the same normal directional vector 'n', must meet when the stress state reaches' the end of the current linear piece of the stress-strain curve.

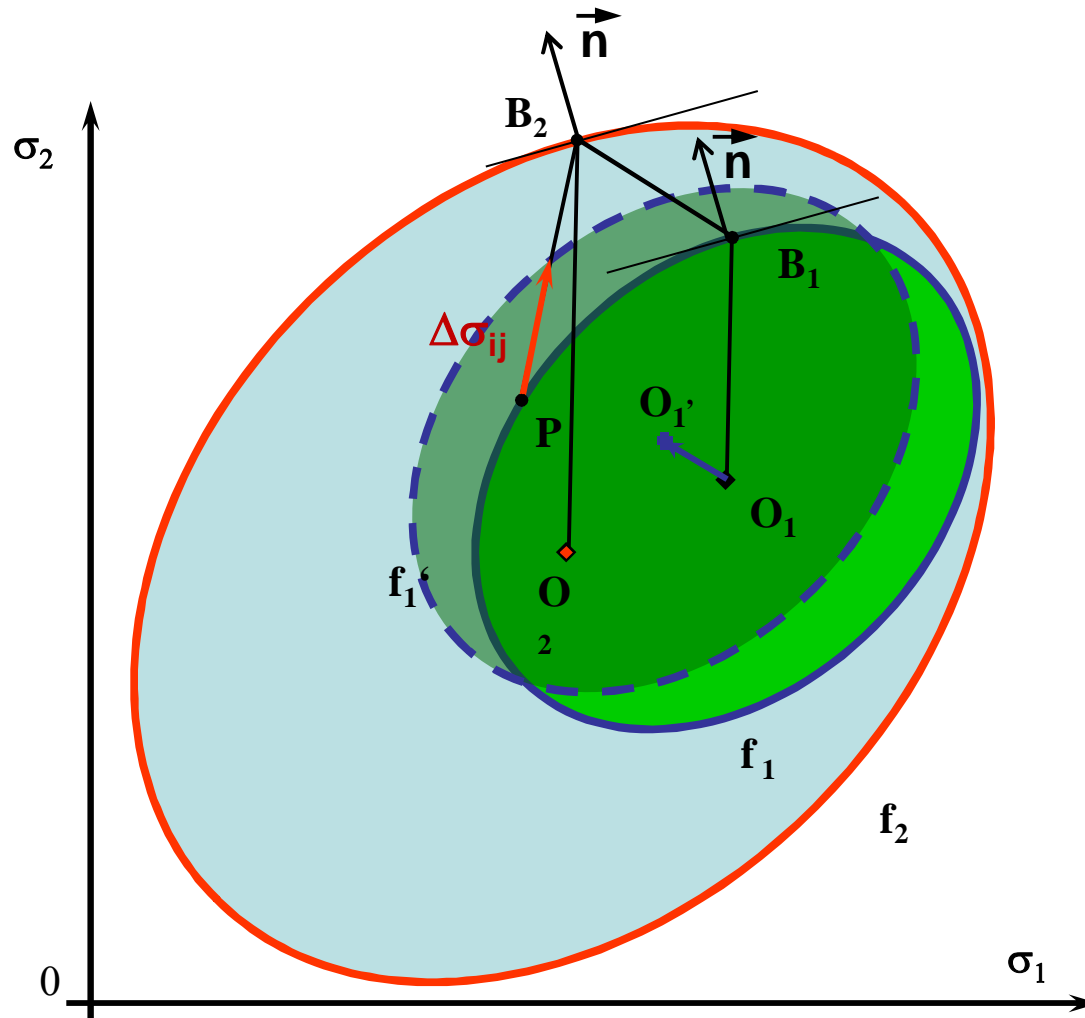

# The essence of the plasticity model:

The multiaxial plasticity model is required for two main reasons:

- a) To identify the current 'plastic modulus' **'H'** for the determination of the relation of plastic strain and associated stress increment, i.e.  $\Delta\varepsilon = \Delta\sigma/H$ .
- b) To model the material memory effect, i.e. to select appropriate modulus **'H'** depending on the previous stress history.
- c) The current modulus is **'H'** defined by the active largest plasticity surface.
- d) When two plasticity surfaces touch each other (at the end of previous linear piece of the stress-strain curve) the larger surface defines the current plastic modulus **'H'** and the current linear piece of the stress-strain curve.

# Translation of plasticity surfaces due to uni-axial cyclic stress state

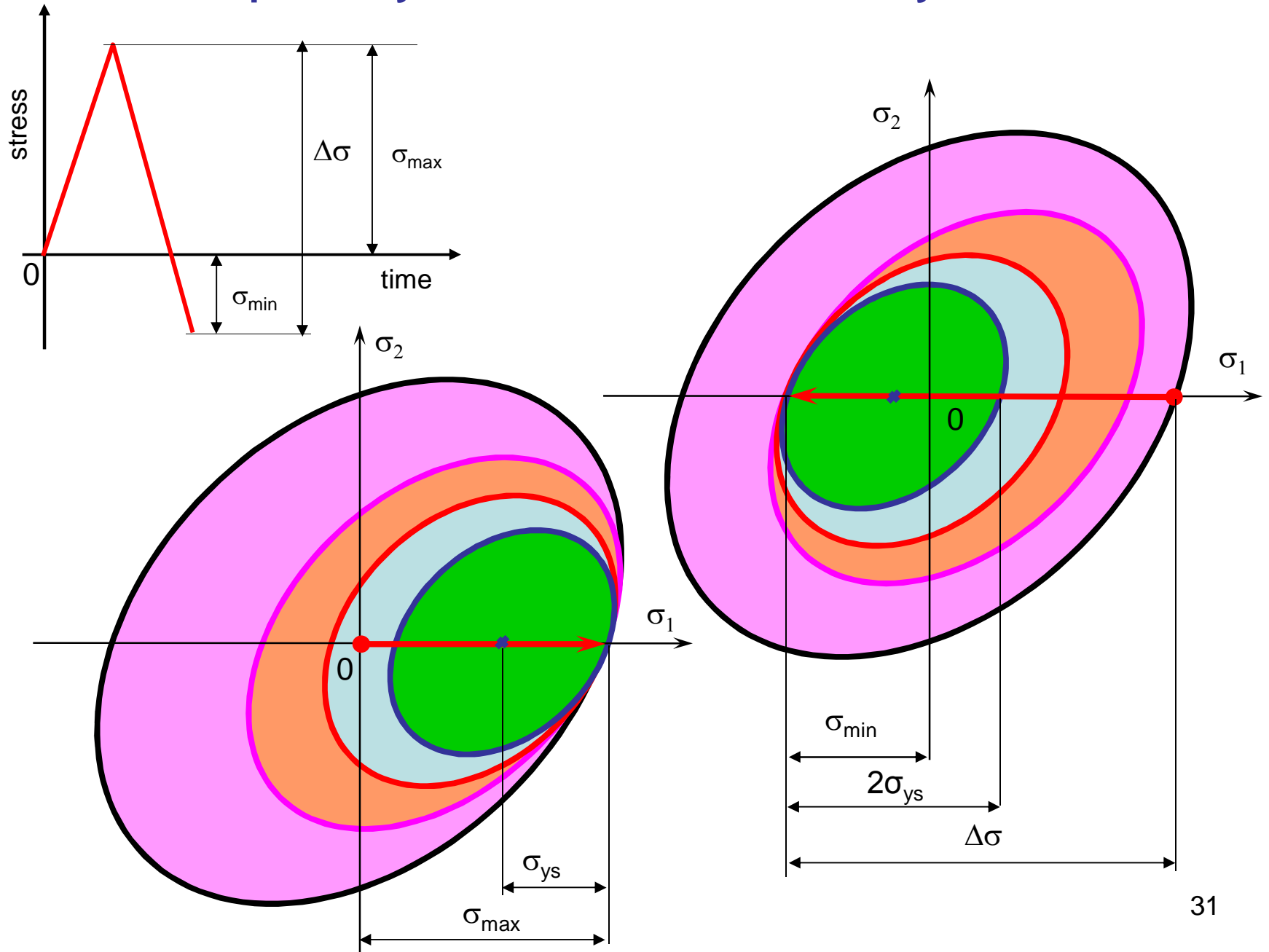

# Translation of plasticity surfaces under bi-axial cyclic load

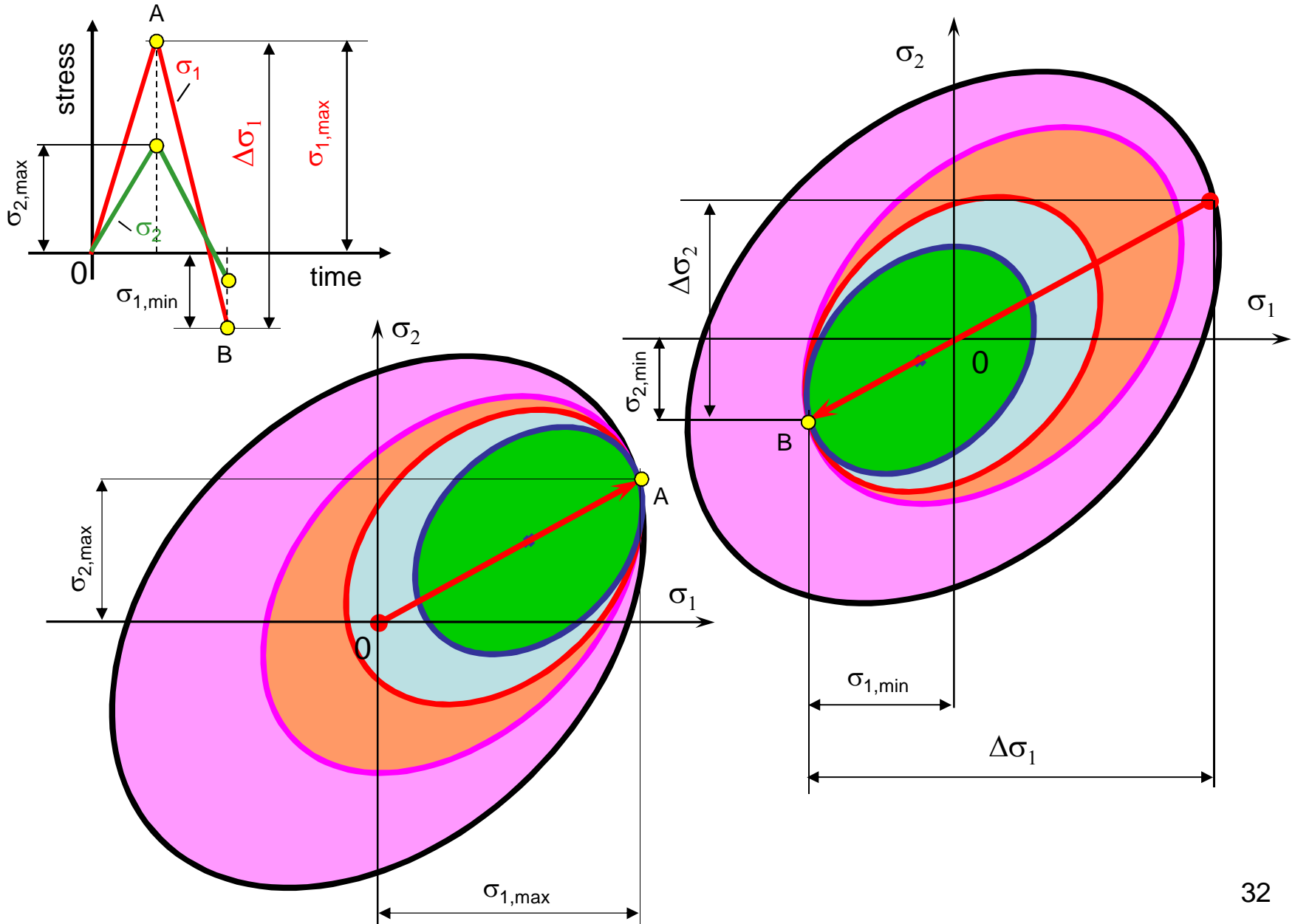



# Translation of Plasticity Surfaces of the Mroz-Garud Model for under arbitrary Non-proportional Loading Path

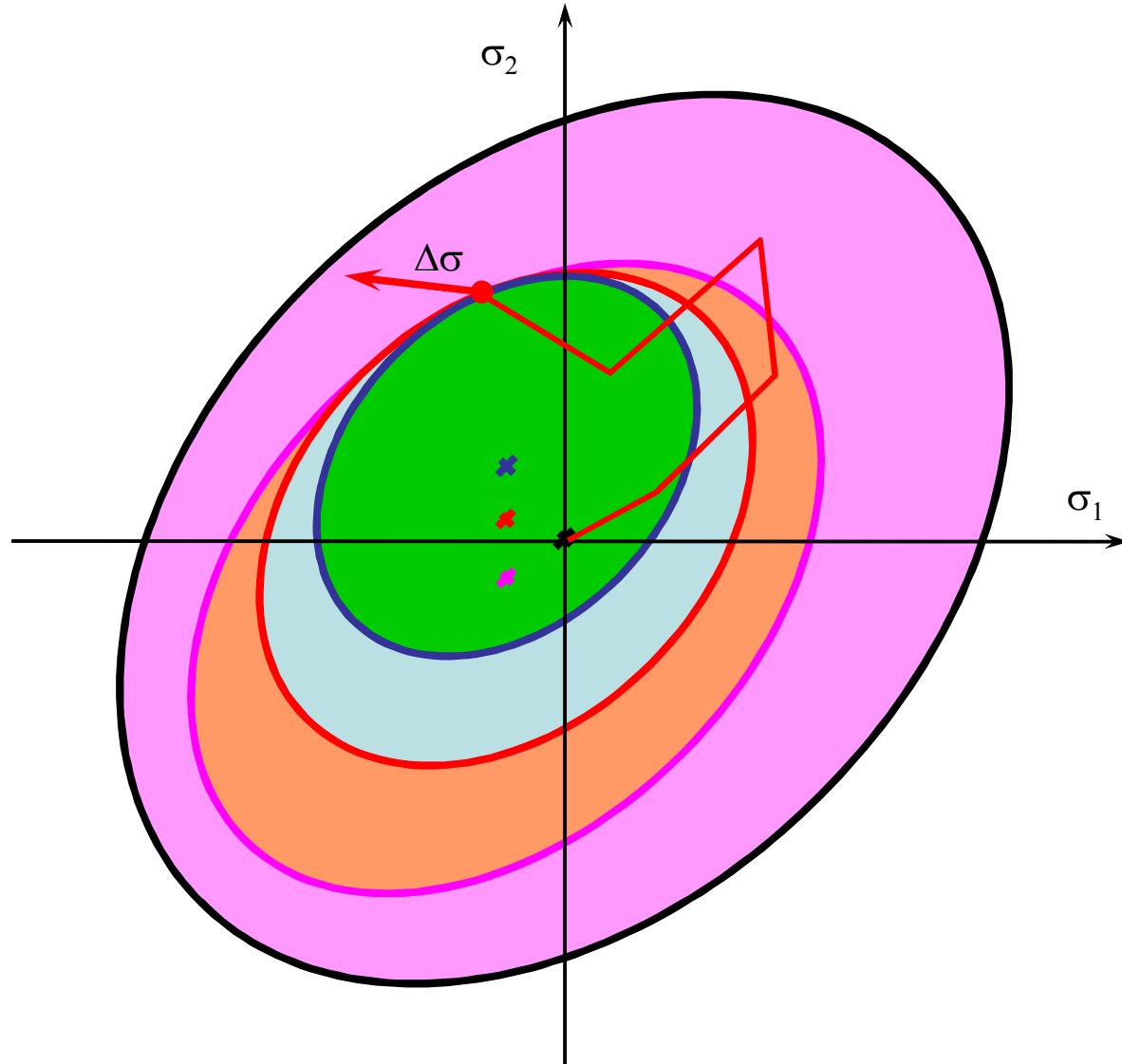

# Material input file (the stress-strain curve)

$\sigma$	$\epsilon$
0,	0
300,	0.0017
400,	0.0027
450,	0.0033
500,	0.0043
550,	0.0058
610,	0.0075
650,	0.0101
700,	0.0159
750,	0.023
800,	0.0311

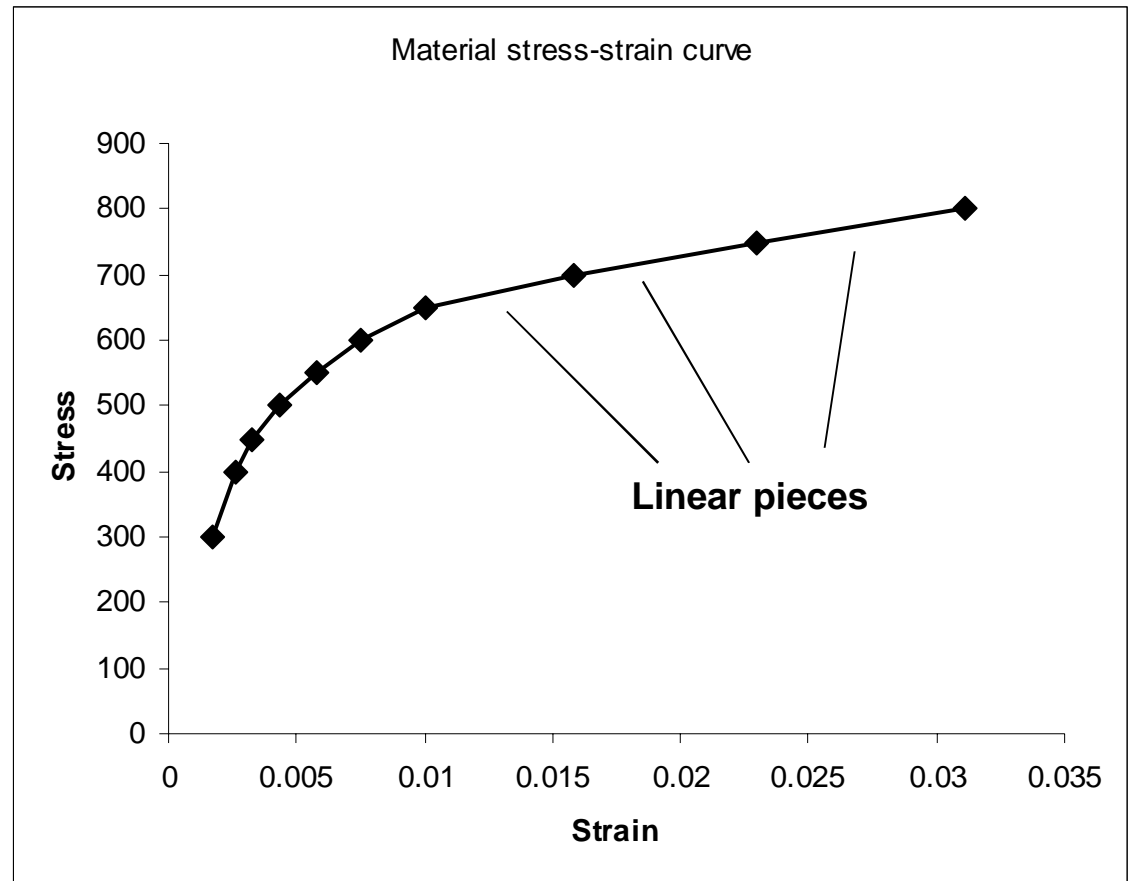

# Input Stress History (smooth material element)

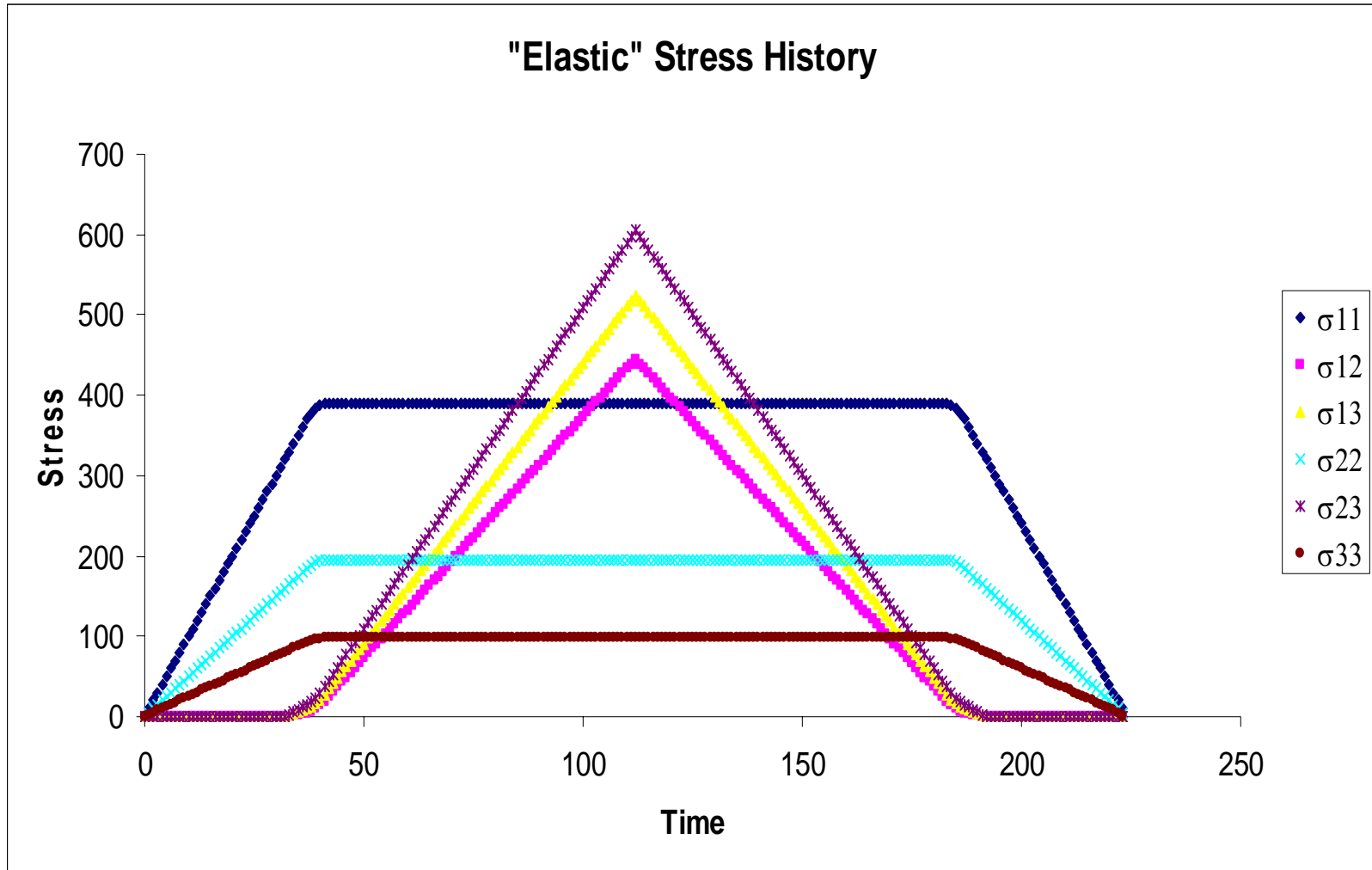

# Resulting Elastic-Plastic Stress Strain Response (smooth element)

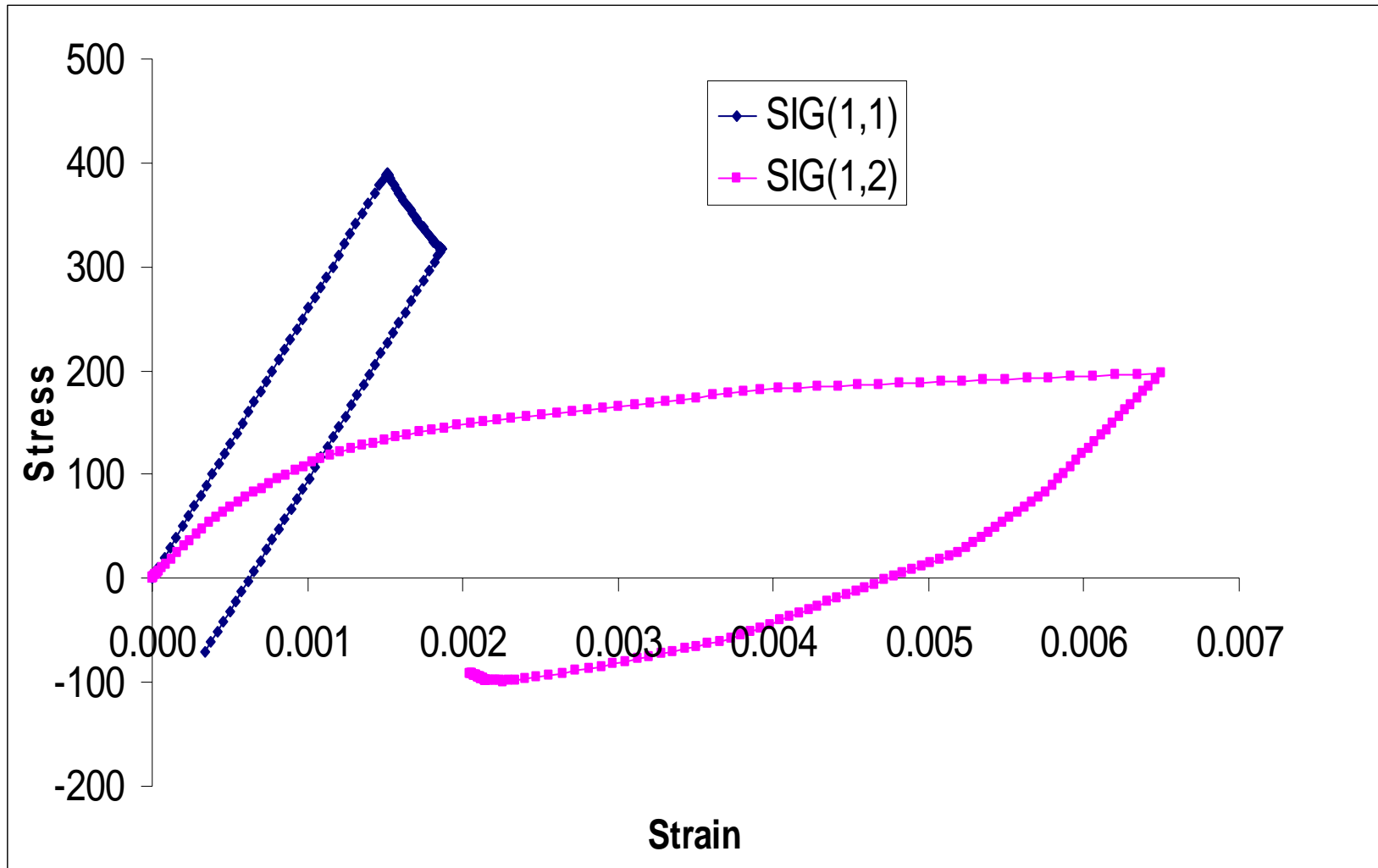

# Notched Bodies:

The cyclic plasticity model and the  
**Neuber/ESED** rule combined

## Stress-Strain States at the Notch Tip - GENERAL

*Elastic input*

$$\Delta \sigma_{ij}^e = \begin{bmatrix} \Delta \sigma_{11}^e & \Delta \sigma_{12}^e & \Delta \sigma_{13}^e \\ \Delta \sigma_{21}^e & \Delta \sigma_{22}^e & \Delta \sigma_{23}^e \\ \Delta \sigma_{31}^e & \Delta \sigma_{32}^e & \Delta \sigma_{33}^e \end{bmatrix}$$

$$\Delta \varepsilon_{ij}^e = \begin{bmatrix} \Delta \varepsilon_{11}^e & \Delta \varepsilon_{12}^e & \Delta \varepsilon_{13}^e \\ \Delta \varepsilon_{21}^e & \Delta \varepsilon_{22}^e & \Delta \varepsilon_{23}^e \\ \Delta \varepsilon_{32}^e & \Delta \varepsilon_{32}^e & \Delta \varepsilon_{33}^e \end{bmatrix}$$

*Elastic-plastic output*

$$\Delta \sigma_{ij}^a = \begin{bmatrix} \Delta \sigma_{11}^a & \Delta \sigma_{12}^a & \Delta \sigma_{13}^a \\ \Delta \sigma_{21}^a & \Delta \sigma_{22}^a & \Delta \sigma_{23}^a \\ \Delta \sigma_{32}^a & \Delta \sigma_{32}^a & \Delta \sigma_{33}^a \end{bmatrix}$$

$$\Delta \varepsilon_{ij}^a = \begin{bmatrix} \Delta \varepsilon_{11}^a & \Delta \varepsilon_{12}^a & \Delta \varepsilon_{13}^a \\ \Delta \varepsilon_{21}^a & \Delta \varepsilon_{22}^a & \Delta \varepsilon_{23}^a \\ \Delta \varepsilon_{31}^a & \Delta \varepsilon_{32}^a & \Delta \varepsilon_{33}^a \end{bmatrix}$$

## Incremental Neuber's Rule

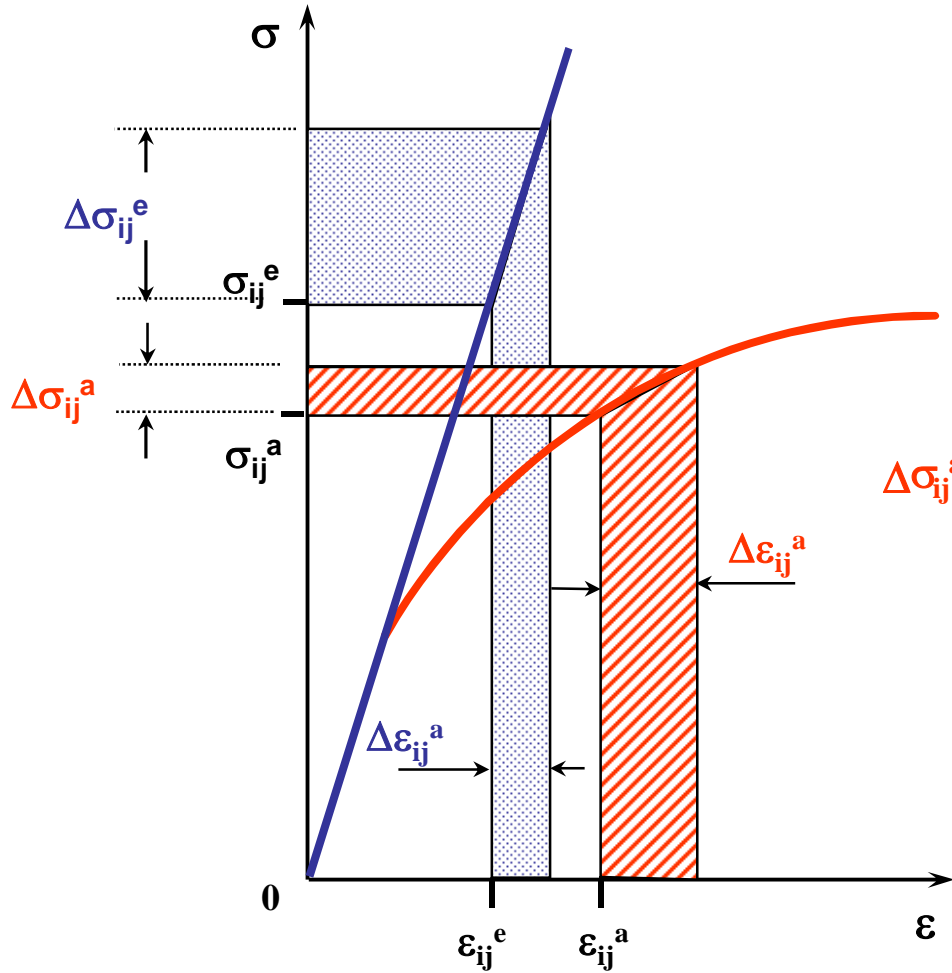

$$\sigma_{\alpha\beta}^e \Delta \varepsilon_{\alpha\beta}^e + \varepsilon_{\alpha\beta}^e \Delta \sigma_{\alpha\beta}^e = \sigma_{\alpha\beta}^a \Delta \varepsilon_{\alpha\beta}^a + \varepsilon_{\alpha\beta}^a \Delta \sigma_{\alpha\beta}^a$$

## Incremental ESED Method

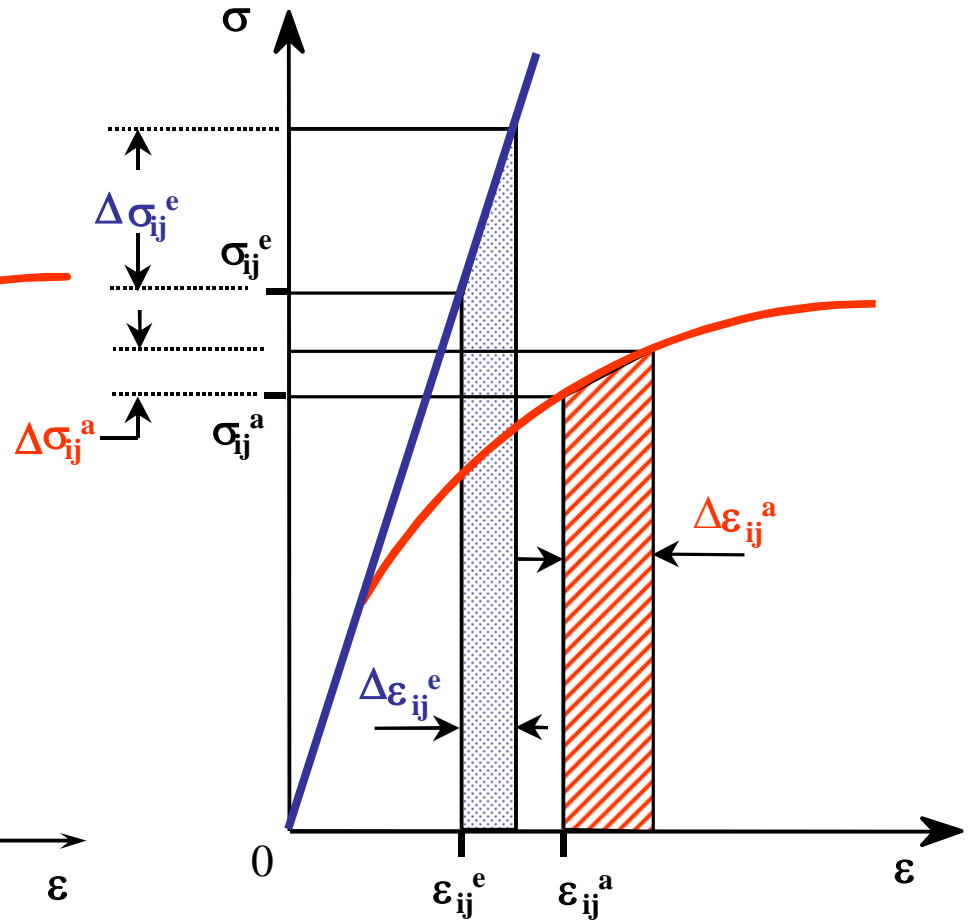

$$\sigma_{\alpha\beta}^e \Delta \varepsilon_{\alpha\beta}^e = \sigma_{\alpha\beta}^a \Delta \varepsilon_{\alpha\beta}^a$$

# General Incremental Multiaxial Neuber's Rule

$$\sigma_{11}^e \Delta \varepsilon_{11}^e + \varepsilon_{11}^e \Delta \sigma_{11}^e = \sigma_{11}^a \Delta \varepsilon_{11}^a + \varepsilon_{11}^a \Delta \sigma_{11}^a$$

$$\sigma_{12}^e \Delta \varepsilon_{12}^e + \varepsilon_{12}^e \Delta \sigma_{12}^e = \sigma_{12}^a \Delta \varepsilon_{12}^a + \varepsilon_{12}^a \Delta \sigma_{12}^a$$

$$\sigma_{13}^e \Delta \varepsilon_{13}^e + \varepsilon_{13}^e \Delta \sigma_{13}^e = \sigma_{13}^a \Delta \varepsilon_{13}^a + \varepsilon_{13}^a \Delta \sigma_{13}^a$$

$$\sigma_{22}^e \Delta \varepsilon_{22}^e + \varepsilon_{22}^e \Delta \sigma_{22}^e = \sigma_{22}^a \Delta \varepsilon_{22}^a + \varepsilon_{22}^a \Delta \sigma_{22}^a$$

$$\sigma_{23}^e \Delta \varepsilon_{23}^e + \varepsilon_{23}^e \Delta \sigma_{23}^e = \sigma_{23}^a \Delta \varepsilon_{23}^a + \varepsilon_{23}^a \Delta \sigma_{23}^a$$

$$\sigma_{33}^e \Delta \varepsilon_{33}^e + \varepsilon_{33}^e \Delta \sigma_{33}^e = \sigma_{33}^a \Delta \varepsilon_{33}^a + \varepsilon_{33}^a \Delta \sigma_{33}^a$$



# Incremental Constitutive Stress-Strain Equations

$$\Delta \varepsilon_{11}^a = \frac{1}{E} \left[ \Delta \sigma_{11}^a - \nu \left( \Delta \sigma_{22}^a + \Delta \sigma_{33}^a \right) \right] + \frac{\Delta \sigma_{eq}^a}{H \sigma_{eq}^a} \left[ \sigma_{11}^a - \frac{1}{2} \left( \sigma_{22}^a + \sigma_{33}^a \right) \right]$$

$$\Delta \varepsilon_{22}^a = \frac{1}{E} \left[ \Delta \sigma_{22}^a - \nu \left( \Delta \sigma_{33}^a + \Delta \sigma_{11}^a \right) \right] + \frac{\Delta \sigma_{eq}^a}{H \sigma_{eq}^a} \left[ \sigma_{22}^a - \frac{1}{2} \left( \sigma_{33}^a + \sigma_{11}^a \right) \right]$$

$$\Delta \varepsilon_{33}^a = \frac{1}{E} \left[ \Delta \sigma_{33}^a - \nu \left( \Delta \sigma_{11}^a + \Delta \sigma_{22}^a \right) \right] + \frac{\Delta \sigma_{eq}^a}{H \sigma_{eq}^a} \left[ \sigma_{33}^a - \frac{1}{2} \left( \sigma_{11}^a + \sigma_{22}^a \right) \right]$$

$$\Delta \varepsilon_{12}^a = \frac{(1+\nu)}{E} \Delta \sigma_{12}^a + \frac{3}{2} \frac{\Delta \sigma_{eq}^a}{H \sigma_{eq}^a} \sigma_{12}^a$$

$$\Delta \varepsilon_{23}^a = \frac{(1+\nu)}{E} \Delta \sigma_{23}^a + \frac{3}{2} \frac{\Delta \sigma_{eq}^a}{H \sigma_{eq}^a} \sigma_{23}^a$$

$$\Delta \varepsilon_{13}^a = \frac{(1+\nu)}{E} \Delta \sigma_{13}^a + \frac{3}{2} \frac{\Delta \sigma_{eq}^a}{H \sigma_{eq}^a} \sigma_{13}^a$$

# General Incremental Multiaxial **ESED** Rule

$$\sigma_{11}^e \Delta \varepsilon_{11}^e = \sigma_{11}^a \Delta \varepsilon_{11}^a$$

$$\sigma_{12}^e \Delta \varepsilon_{12}^e = \sigma_{12}^a \Delta \varepsilon_{12}^a$$

$$\sigma_{13}^e \Delta \varepsilon_{13}^e = \sigma_{13}^a \Delta \varepsilon_{13}^a$$

$$\sigma_{22}^e \Delta \varepsilon_{22}^e = \sigma_{22}^a \Delta \varepsilon_{22}^a$$

$$\sigma_{23}^e \Delta \varepsilon_{23}^e = \sigma_{23}^a \Delta \varepsilon_{23}^a$$

$$\sigma_{33}^e \Delta \varepsilon_{33}^e = \sigma_{33}^a \Delta \varepsilon_{33}^a$$

# Incremental Constitutive Stress-Strain Equations

$$\Delta \varepsilon_{11}^a = \frac{1}{E} \left[ \Delta \sigma_{11}^a - \nu \left( \Delta \sigma_{22}^a + \Delta \sigma_{33}^a \right) \right] + \frac{\Delta \sigma_{eq}^a}{H \sigma_{eq}^a} \left[ \sigma_{11}^a - \frac{1}{2} \left( \sigma_{22}^a + \sigma_{33}^a \right) \right]$$

$$\Delta \varepsilon_{22}^a = \frac{1}{E} \left[ \Delta \sigma_{22}^a - \nu \left( \Delta \sigma_{33}^a + \Delta \sigma_{11}^a \right) \right] + \frac{\Delta \sigma_{eq}^a}{H \sigma_{eq}^a} \left[ \sigma_{22}^a - \frac{1}{2} \left( \sigma_{33}^a + \sigma_{11}^a \right) \right]$$

$$\Delta \varepsilon_{33}^a = \frac{1}{E} \left[ \Delta \sigma_{33}^a - \nu \left( \Delta \sigma_{11}^a + \Delta \sigma_{22}^a \right) \right] + \frac{\Delta \sigma_{eq}^a}{H \sigma_{eq}^a} \left[ \sigma_{33}^a - \frac{1}{2} \left( \sigma_{11}^a + \sigma_{22}^a \right) \right]$$

$$\Delta \varepsilon_{12}^a = \frac{(1+\nu)}{E} \Delta \sigma_{12}^a + \frac{3}{2} \frac{\Delta \sigma_{eq}^a}{H \sigma_{eq}^a} \sigma_{12}^a$$

$$\Delta \varepsilon_{23}^a = \frac{(1+\nu)}{E} \Delta \sigma_{23}^a + \frac{3}{2} \frac{\Delta \sigma_{eq}^a}{H \sigma_{eq}^a} \sigma_{23}^a$$

$$\Delta \varepsilon_{13}^a = \frac{(1+\nu)}{E} \Delta \sigma_{13}^a + \frac{3}{2} \frac{\Delta \sigma_{eq}^a}{H \sigma_{eq}^a} \sigma_{13}^a$$

# **Notched Bodies:**

## **Non-Proportional Monotonic Loading Path**

**(Mutiaxial Neuber/ESED method vs. FEM)**

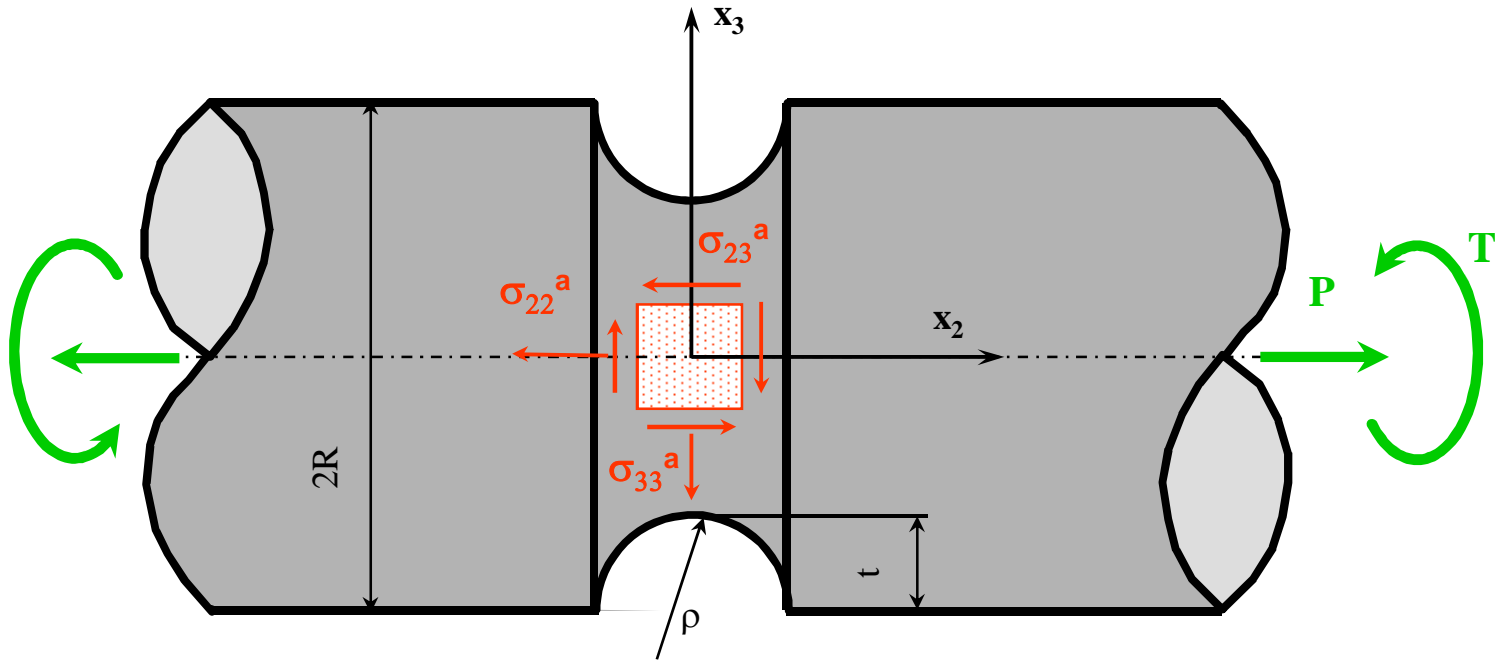

$$\begin{cases} \varepsilon = \frac{\sigma}{E} & \text{for } \sigma \leq \sigma_0 \\ \varepsilon = \frac{\sigma}{E} + \frac{\sigma - \sigma_0}{H} & \text{for } \sigma > \sigma_0 \end{cases}$$

$$K_P = 3.89 \quad K_T = 2.19$$

$$\frac{\sigma_{33}^e}{\sigma_{22}^e} = 0.27 \quad \frac{\tau_n}{\sigma_n} = 0.27$$

$$E = 94400 \text{ MPa}, \nu = 0.3,$$

$$H = 4720 \text{ MPa}, \sigma_0 = 550 \text{ MPa}$$

# Material Curve ~SAE 1045

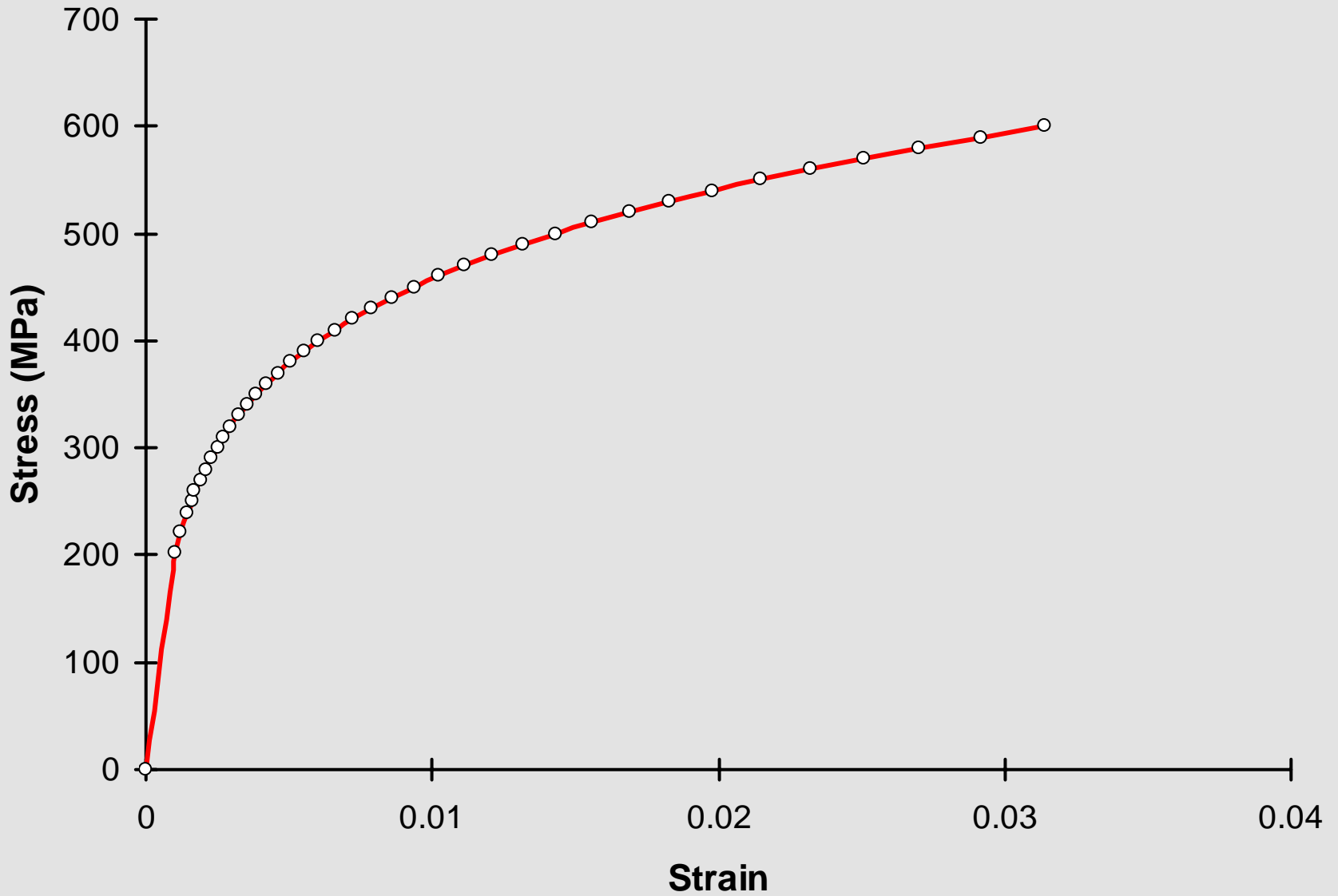

# Torsion-Tension Non-Proportional Loading Path (torsion followed by tension)

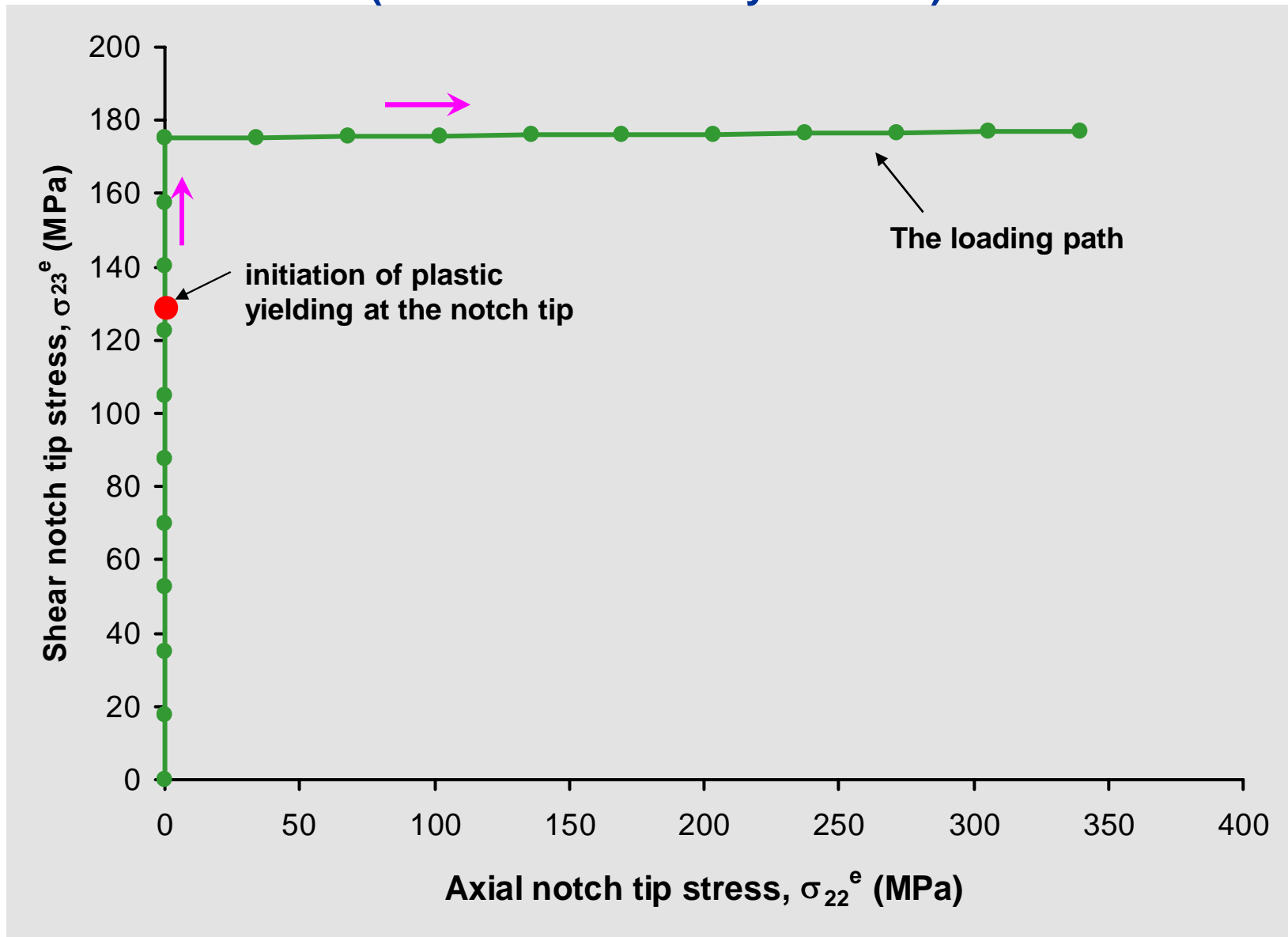

# Shear vs. normal elastic-plastic notch tip strains

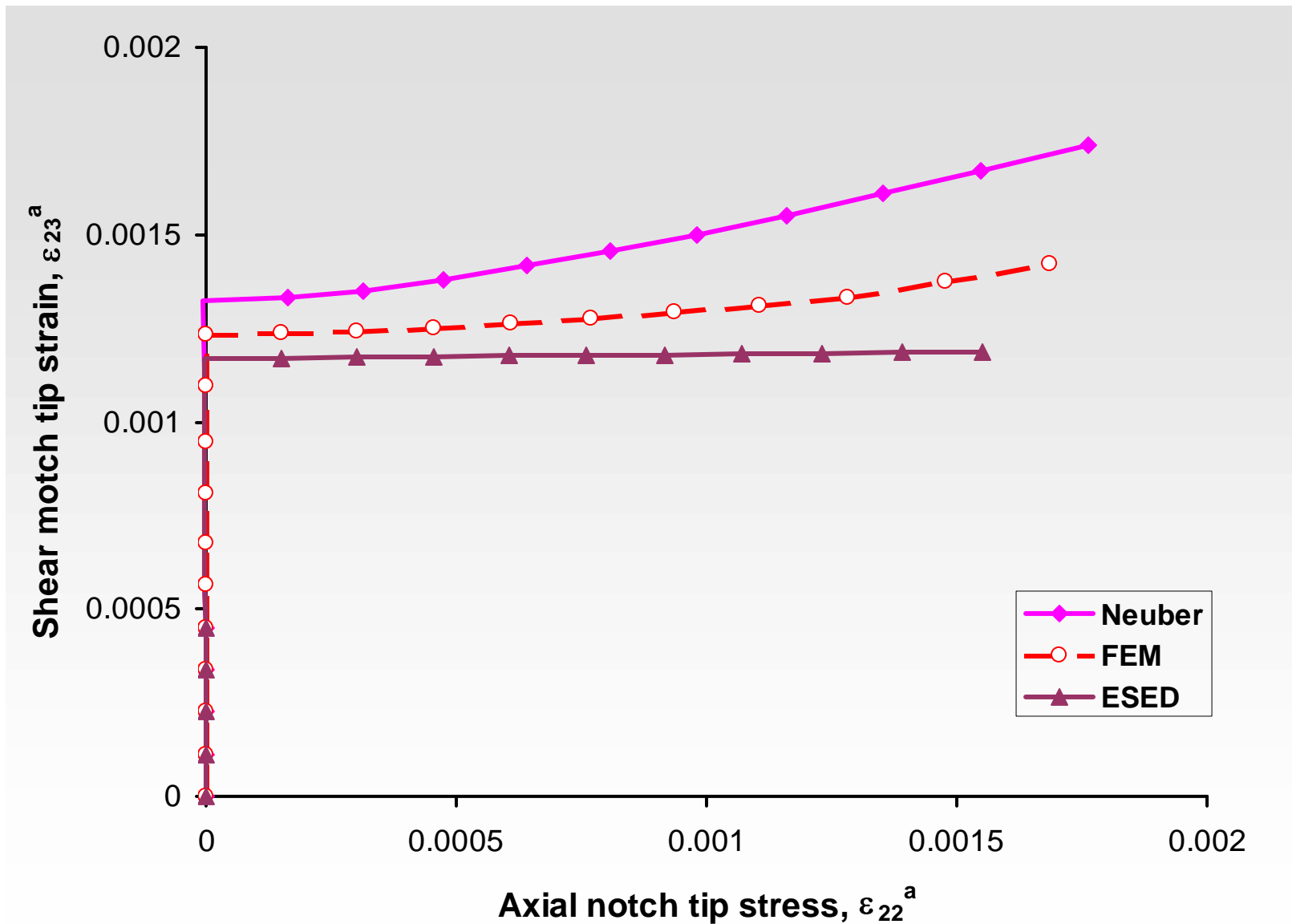



# The shear vs. normal notch tip stresses

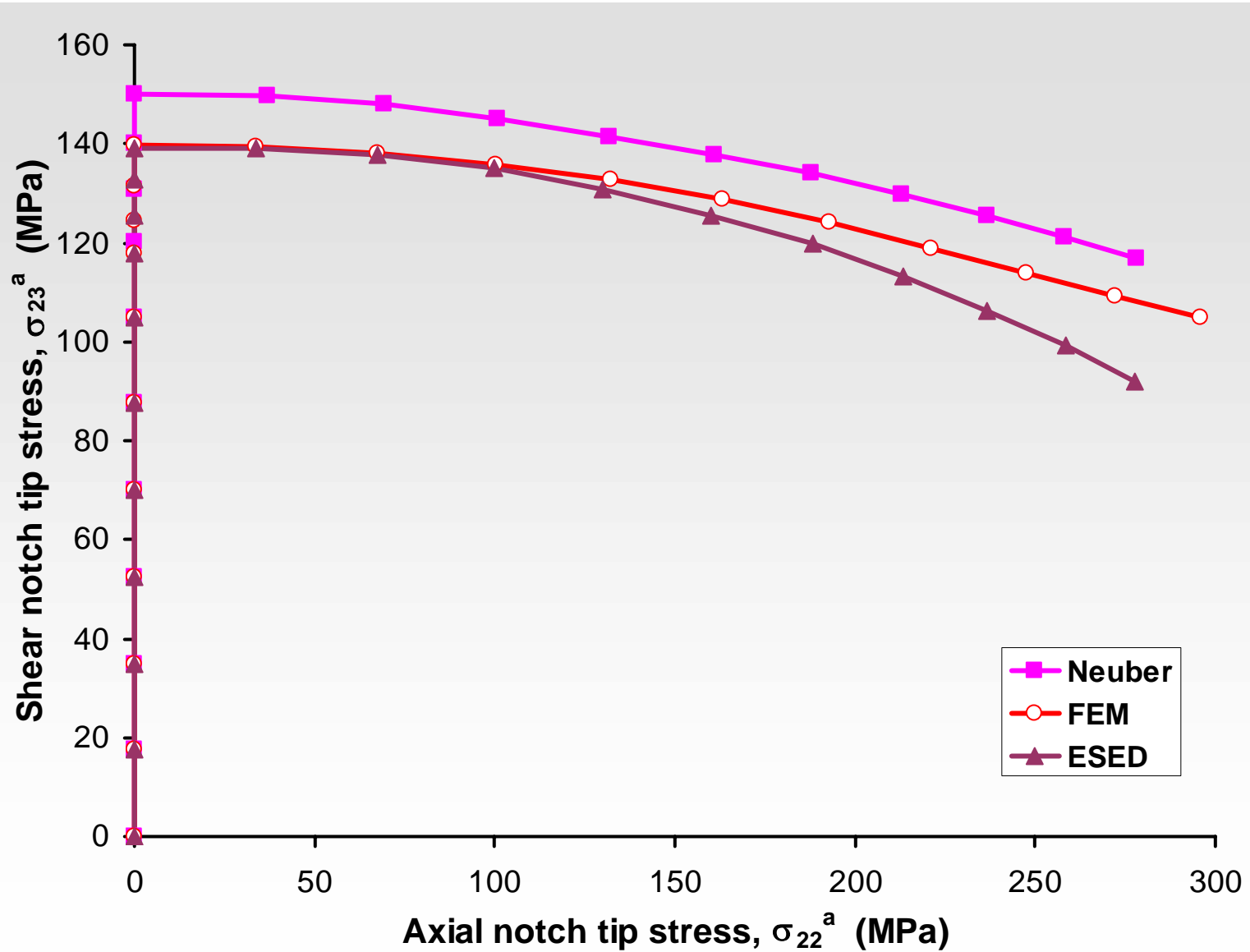

# Notched Bodies:

## Non-Proportional Cyclic Loading Paths (Mutiaxial **Neuber/ESED** method vs. **Experiments**)

Experimental data:  
Courtesy of D. Socie and P. Kurath,  
University of Illinois, USA

# Cylindrical Notched Specimen under Tension and Torsion Loading (Non-Proportional Cyclic Loading Paths)

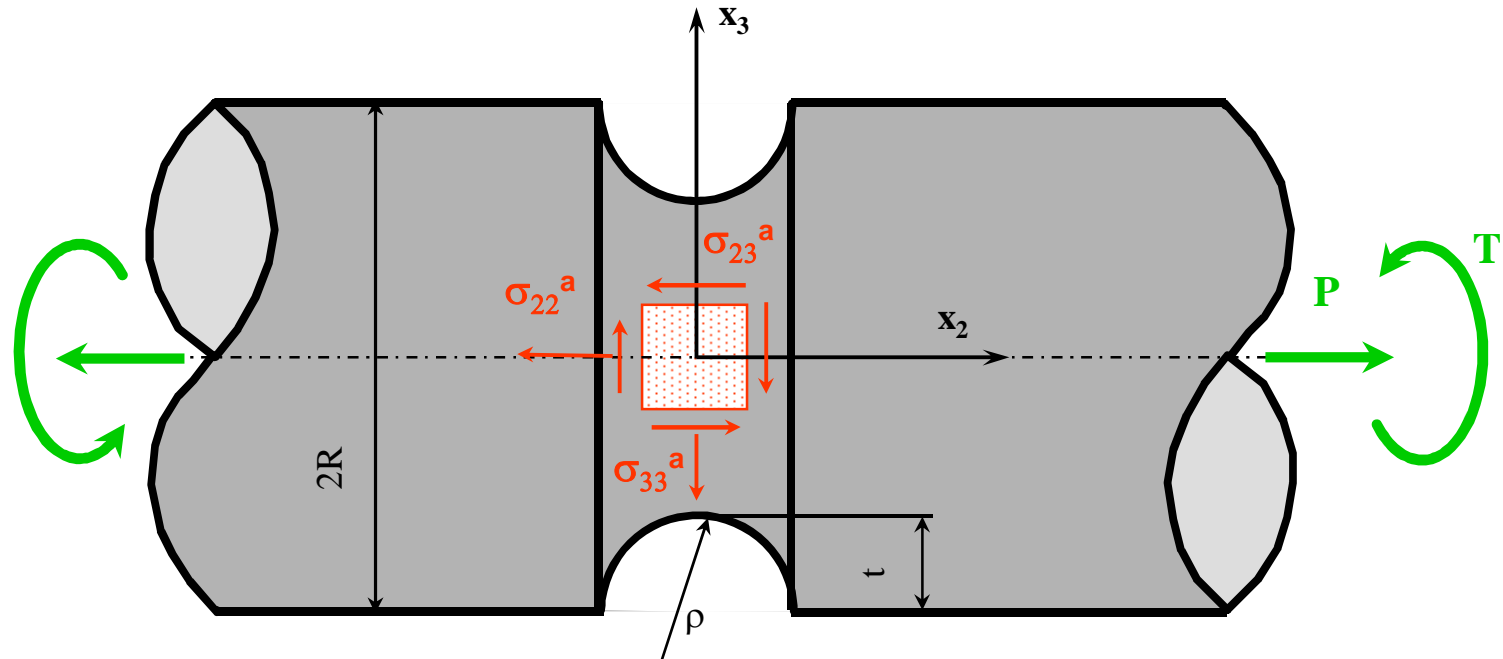

$$\begin{cases} \varepsilon = \frac{\sigma}{E} & \text{for } \sigma \leq \sigma_0 \\ \varepsilon = \frac{\sigma}{E} + \frac{\sigma - \sigma_0}{H} & \text{for } \sigma > \sigma_0 \end{cases}$$

$$E = 94400 \text{ MPa}, \nu = 0.3,$$

$$H = 4720 \text{ MPa}, \sigma_0 = 550 \text{ MPa}$$

$$K_P = 3.89 \quad K_T = 2.19$$

$$\frac{\sigma_{33}^e}{\sigma_{22}^e} = 0.27 \quad \frac{\tau_n}{\sigma_n} = 0.27$$

## Material - 1070 Steel

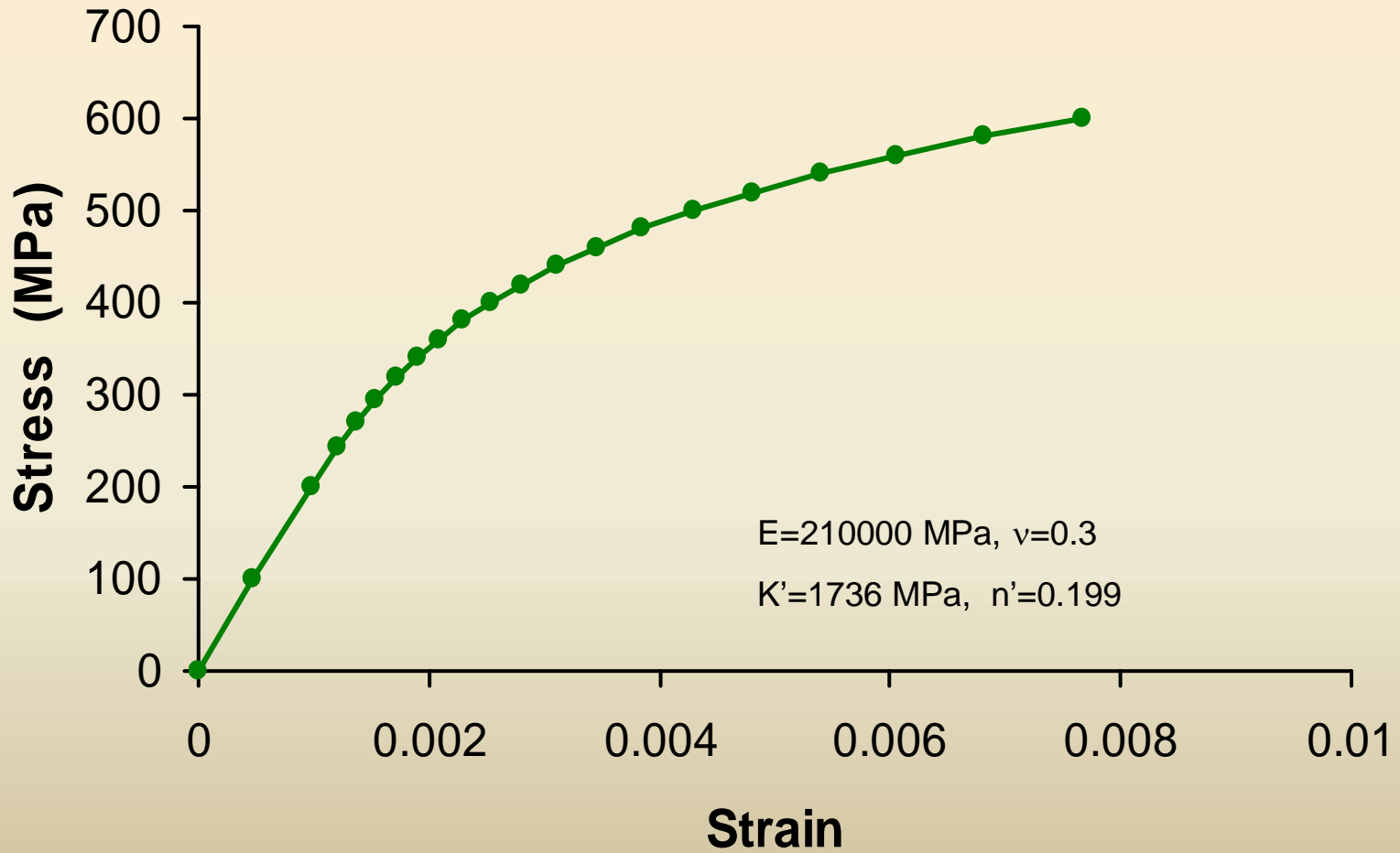

# Hypothetical (elastic) shear vs. normal notch tip Input stresses

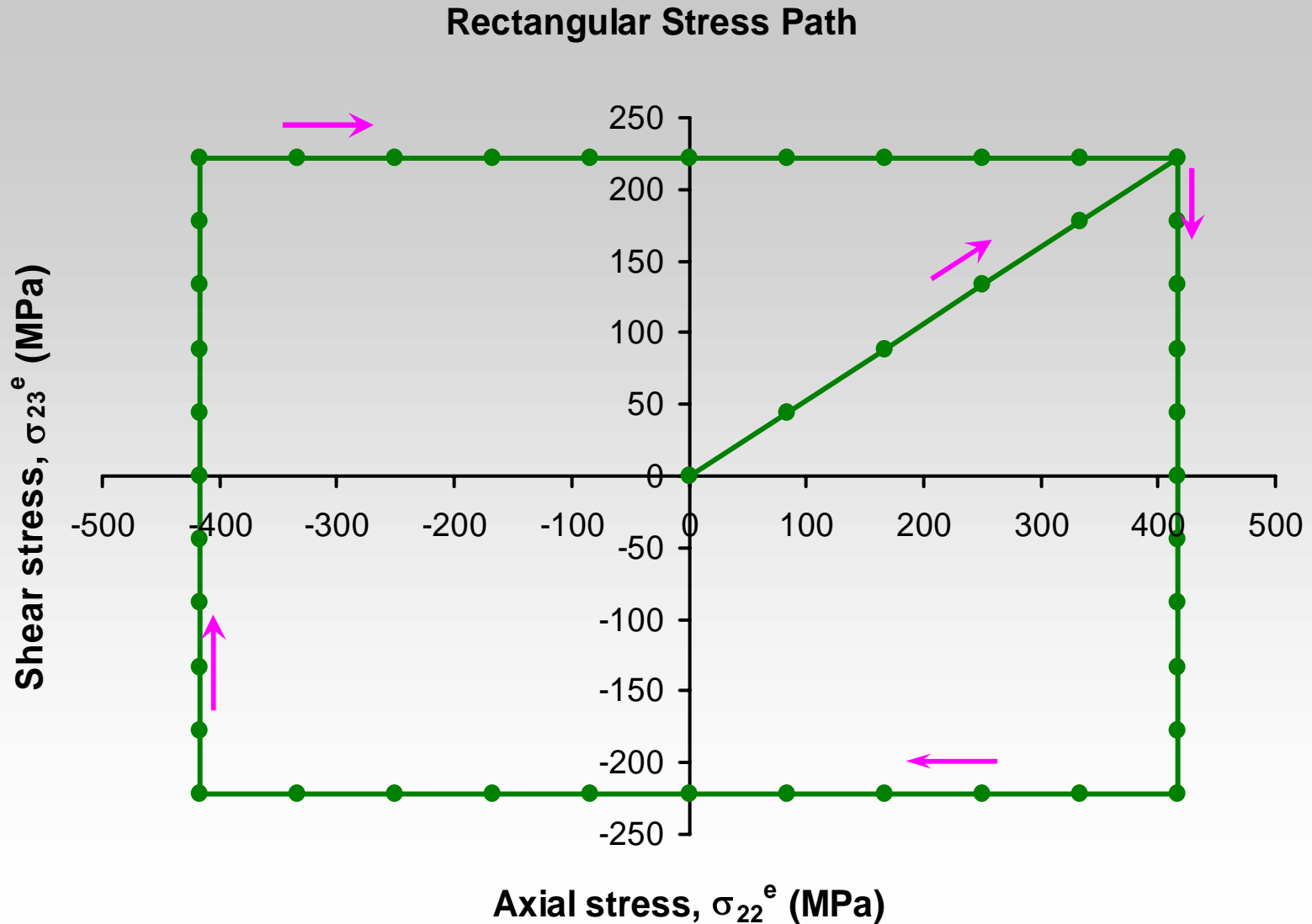

# Shear vs. normal elastic-plastic notch tip strains (calculated vs. measured)

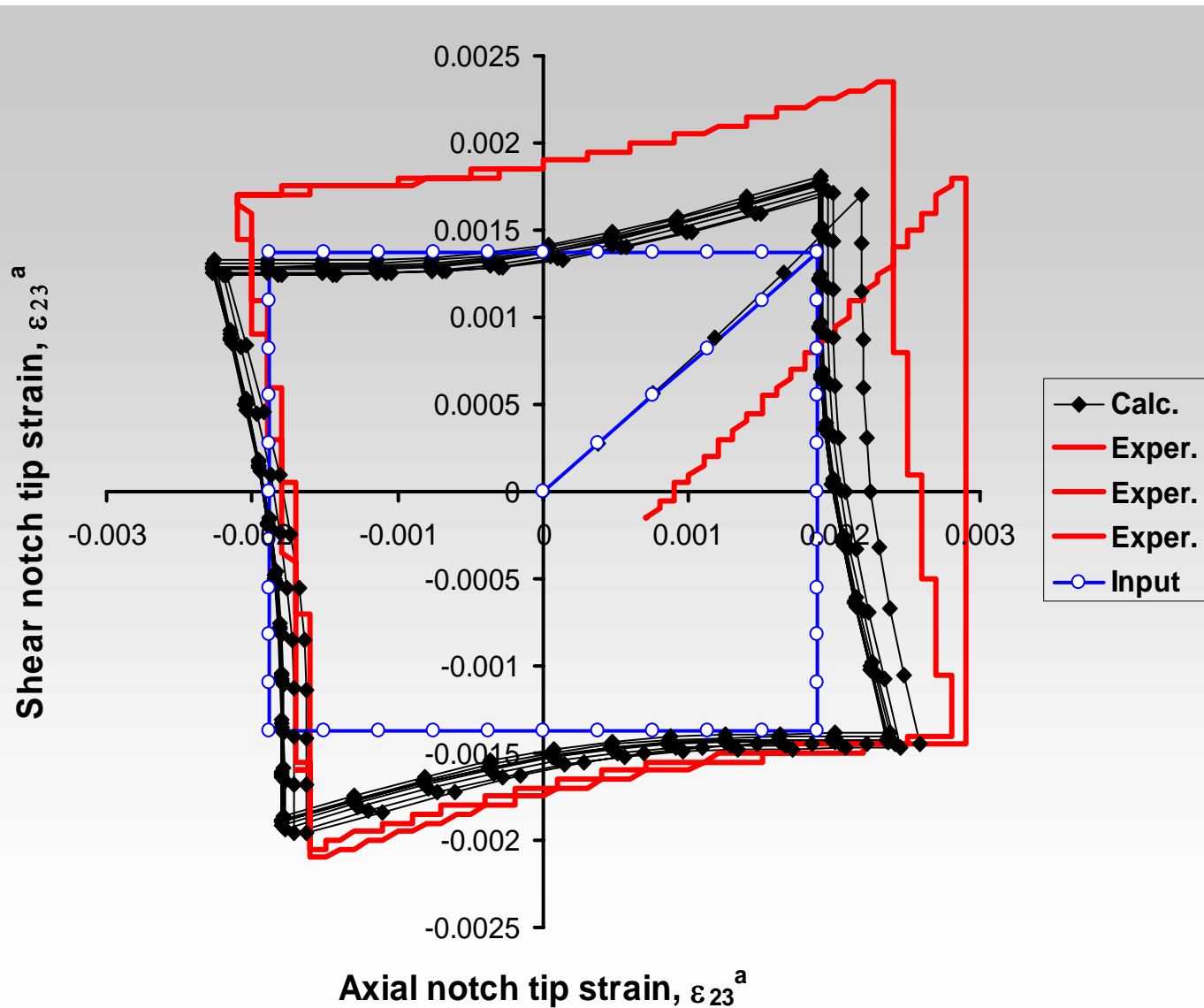

# Calculated shear vs. normal notch tip stresses

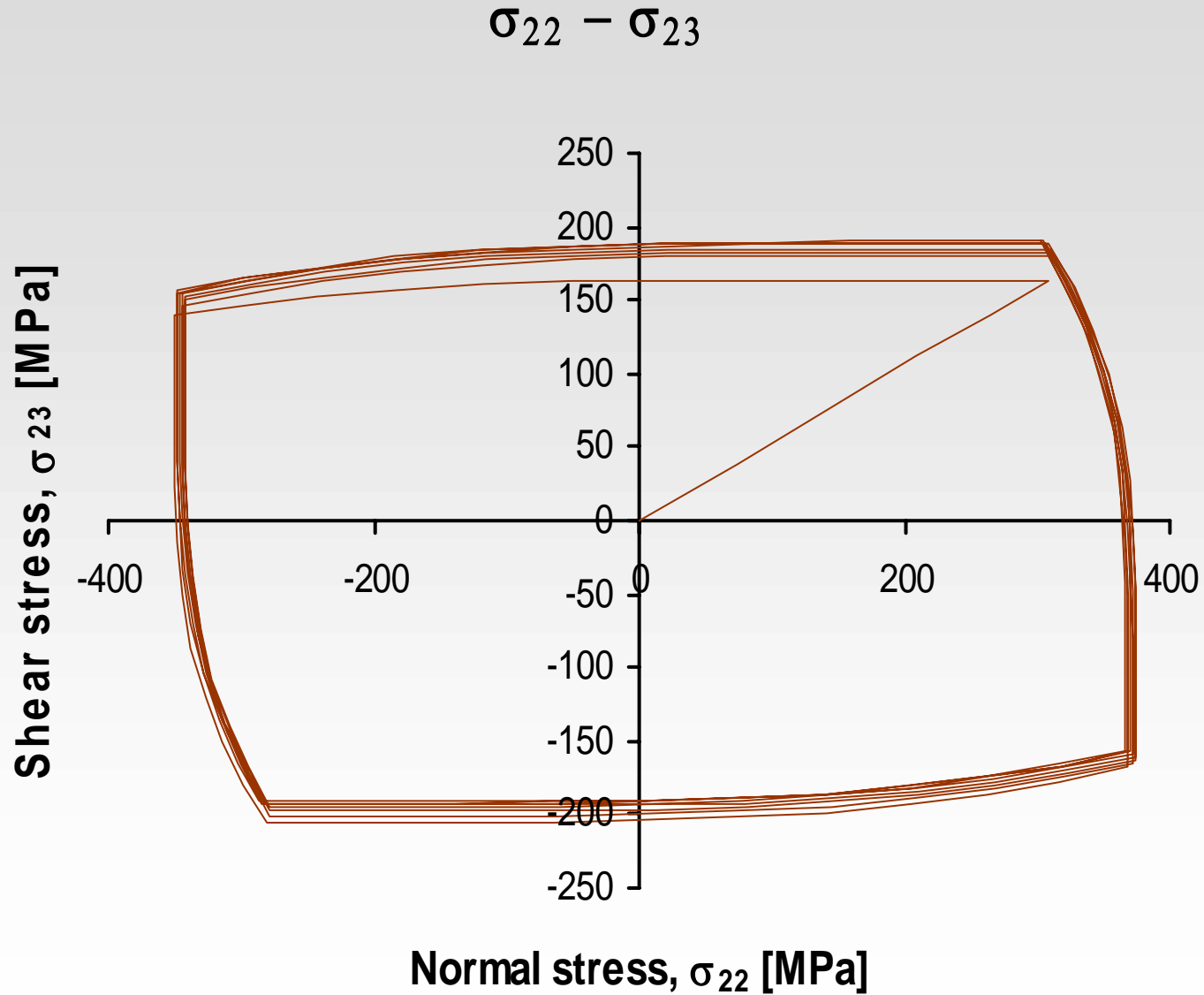

# Elastic-Plastic Stress-Strain paths at the notch tip

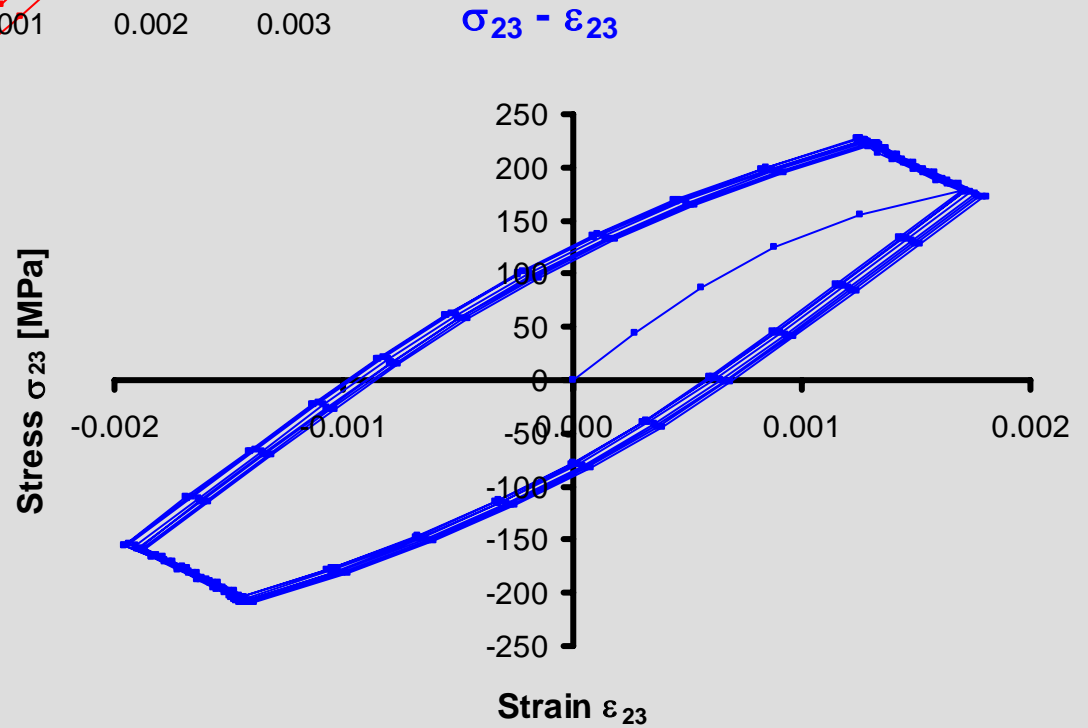
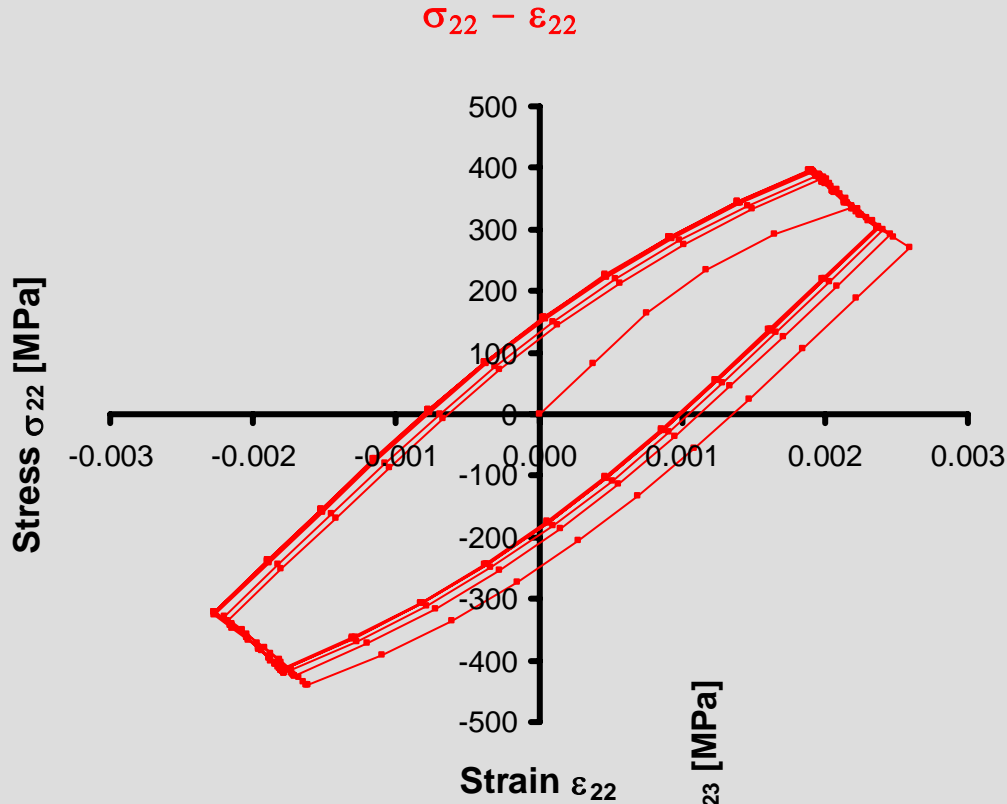



# Shear vs. normal notch tip hypothetical-elastic Input Stresses

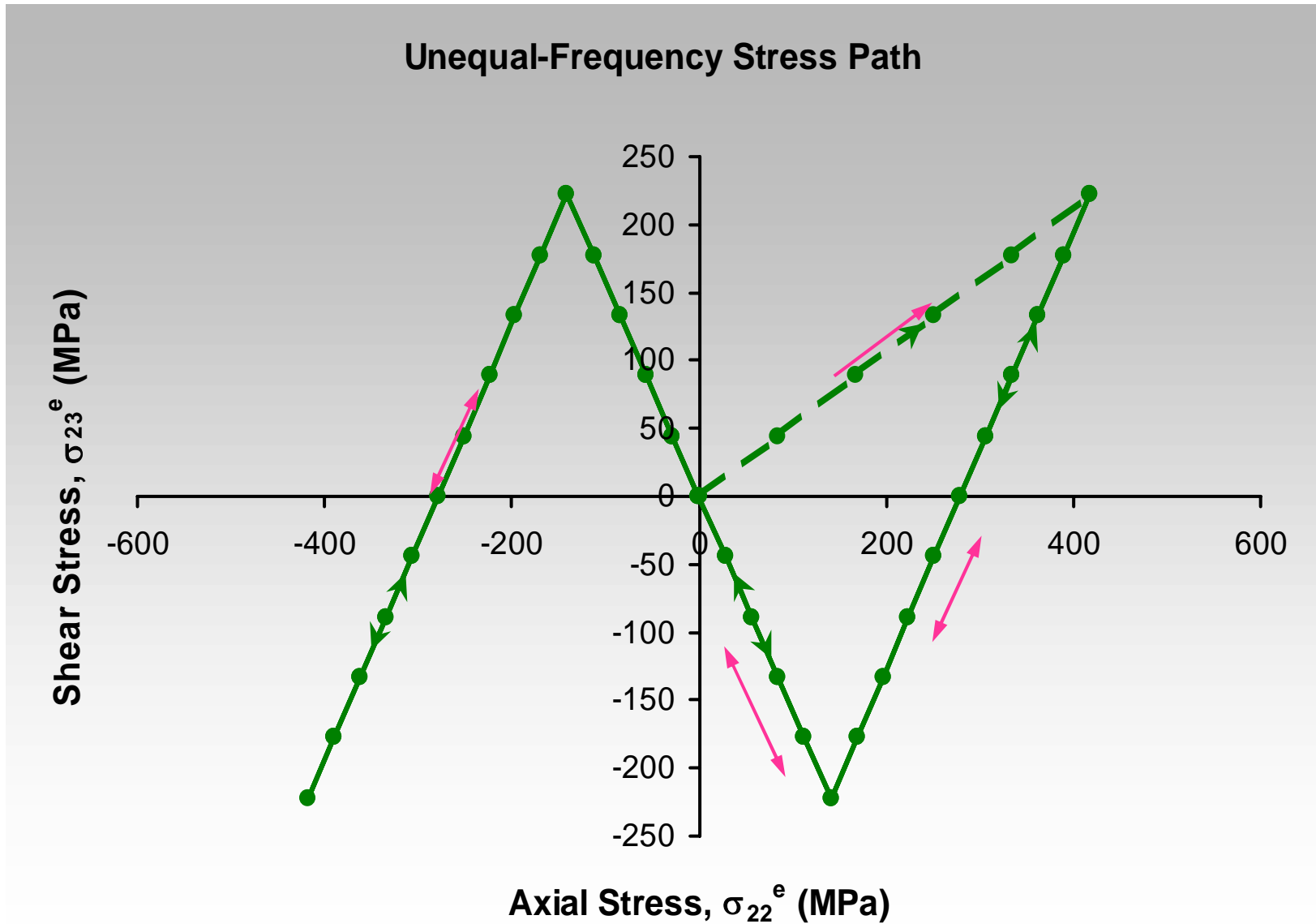

# Shear vs. normal elastic-plastic notch tip strains (calculated vs. measured)

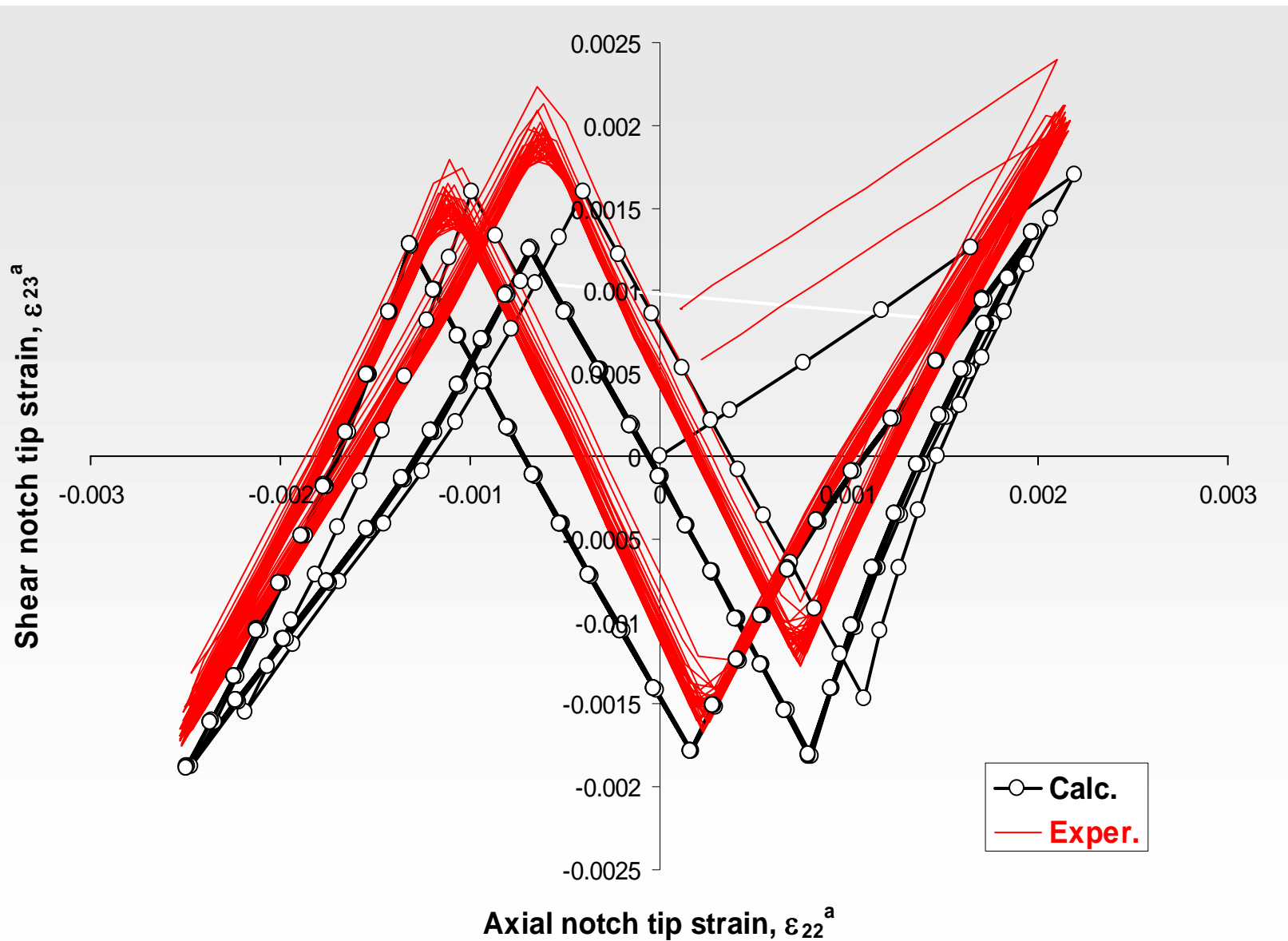

# FEM and Neuber elastic-plastic notch tip stress-strain components induced by asymmetric non-proportional stress-path

### Elastic Stress Path, $\sigma - \tau$

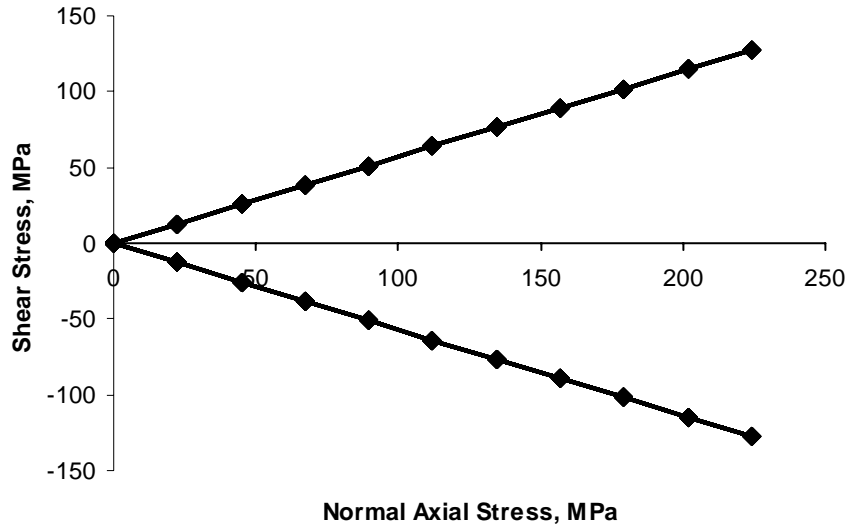

### Material stress-strain curve

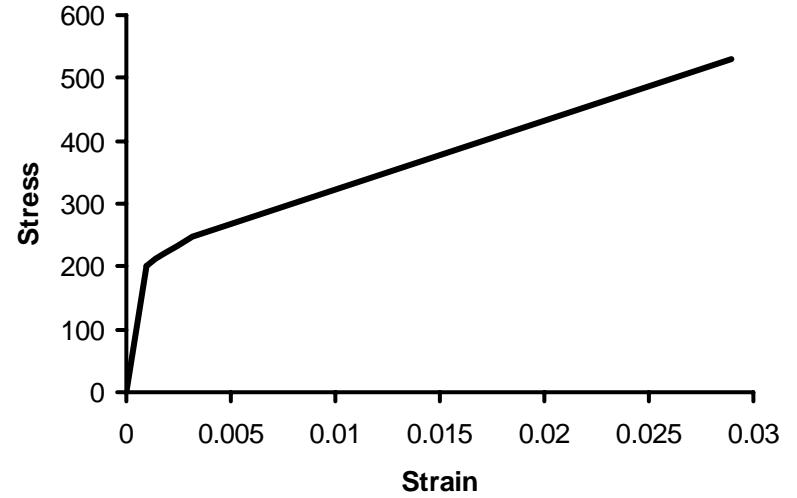

### Axial stress-Axial strain, $\sigma - \epsilon$

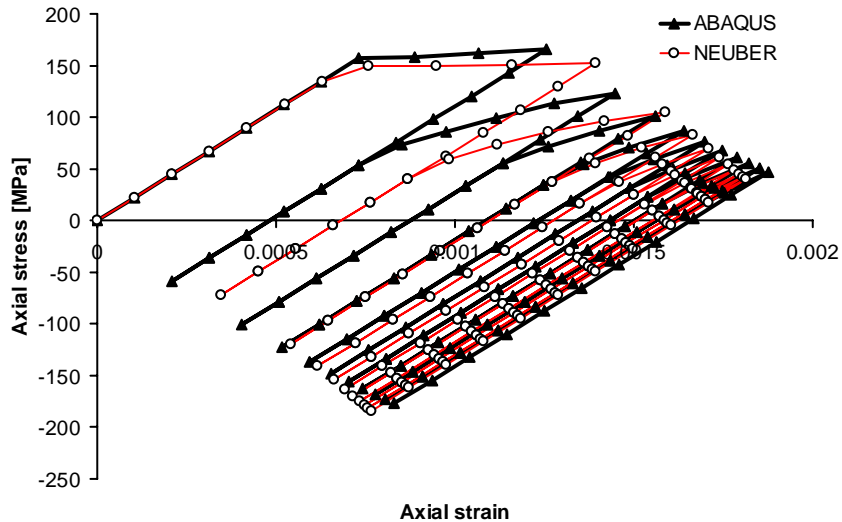

### Shear stress-Shear strain

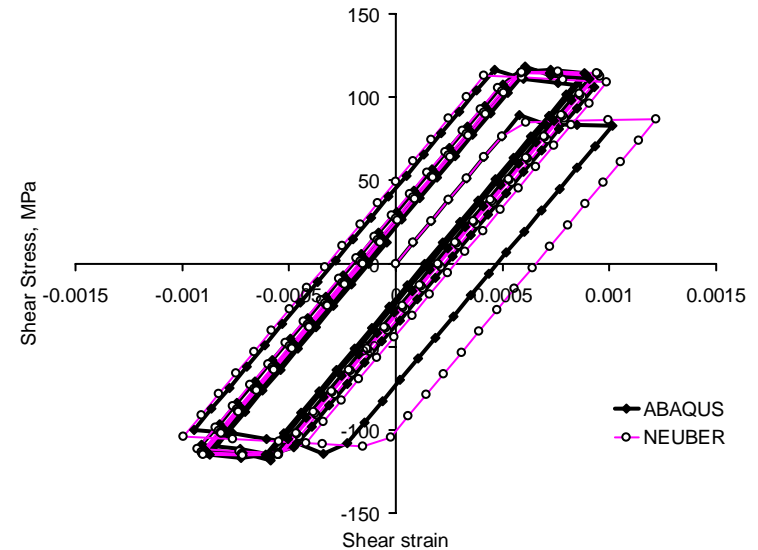



**Cyclic Plasticity, Notches??**

**Enough for now!!!**